

APPROX. WEIGHT (LBS)
127

ECO No	DESCRIPTION	REV BY	DATE

CRITICAL TO QUALITY CLASSIFICATION TABLE				
<small> P-PERFORMANCE FIT ASSEMBLY F-IDENTIFIED APPLICABLE CLASSIFICATION S-ENGINEERING AND/OR MANUFACTURING REQUIREMENT R-REGULATORY REQUIREMENT/COMPLIANCE IS MANDATORY </small>				
COMMENTS	DRAWING ZONE	P	F	R
ROHS	G1-H1			X

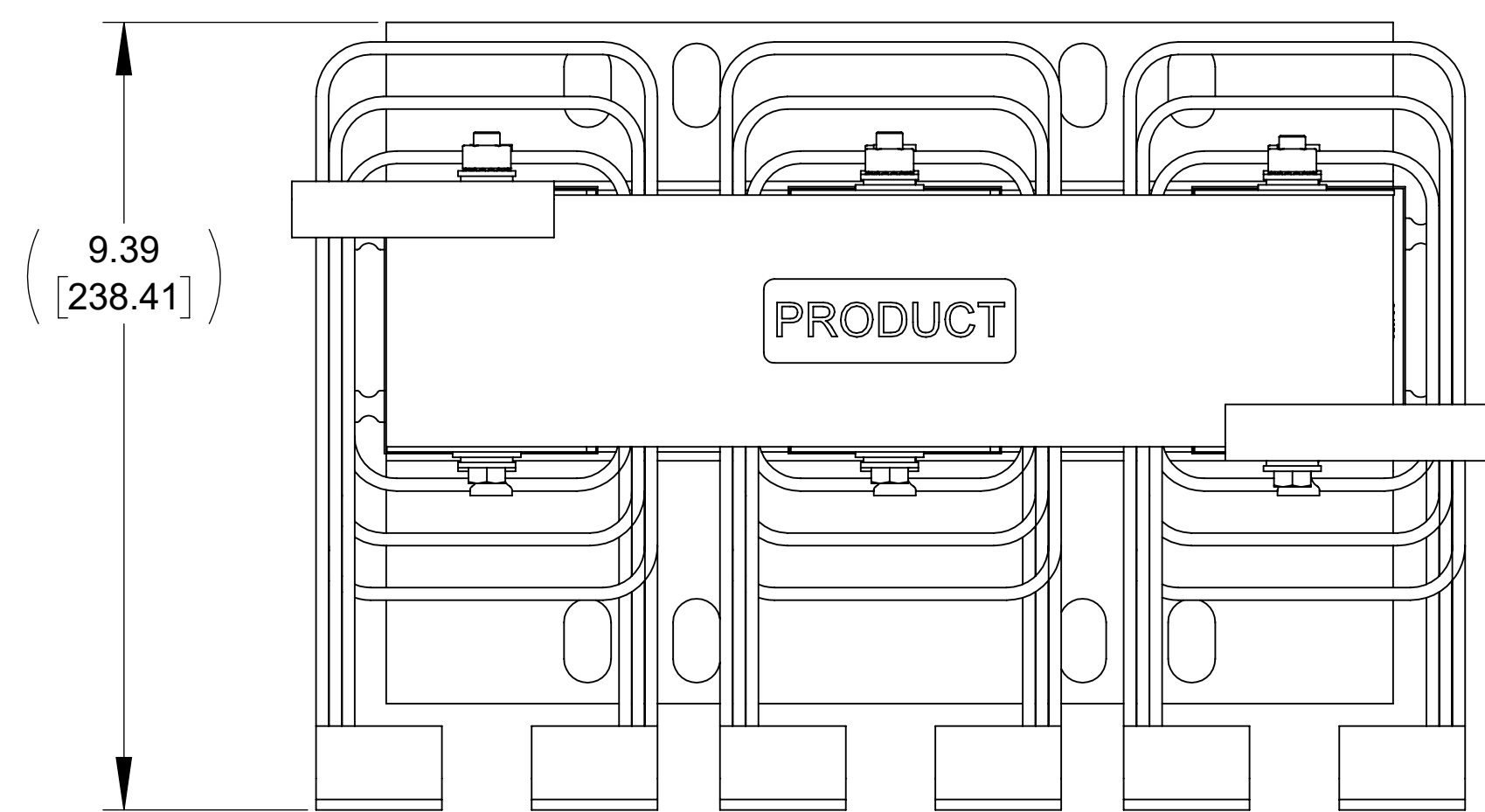
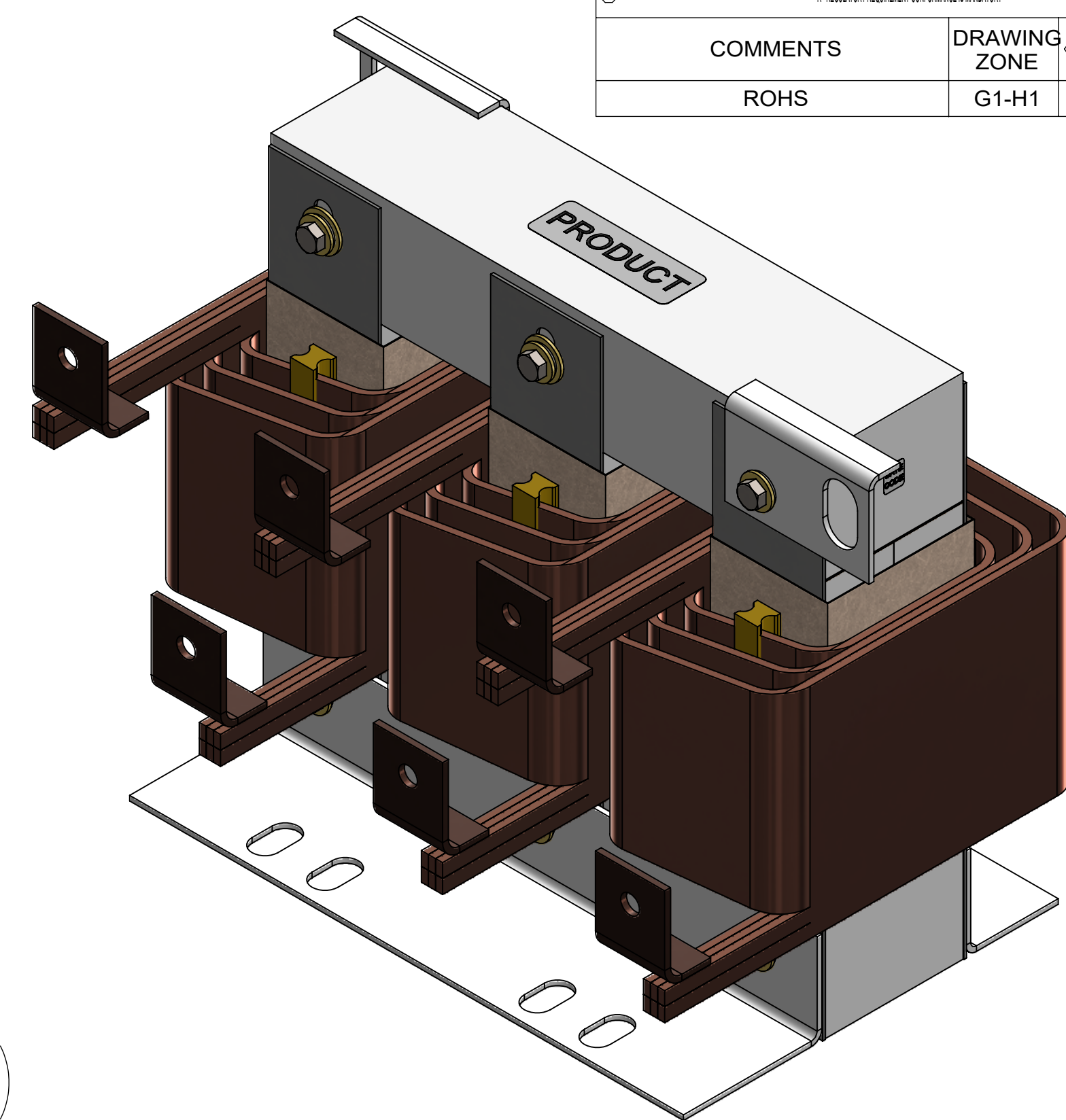

TOP VIEW

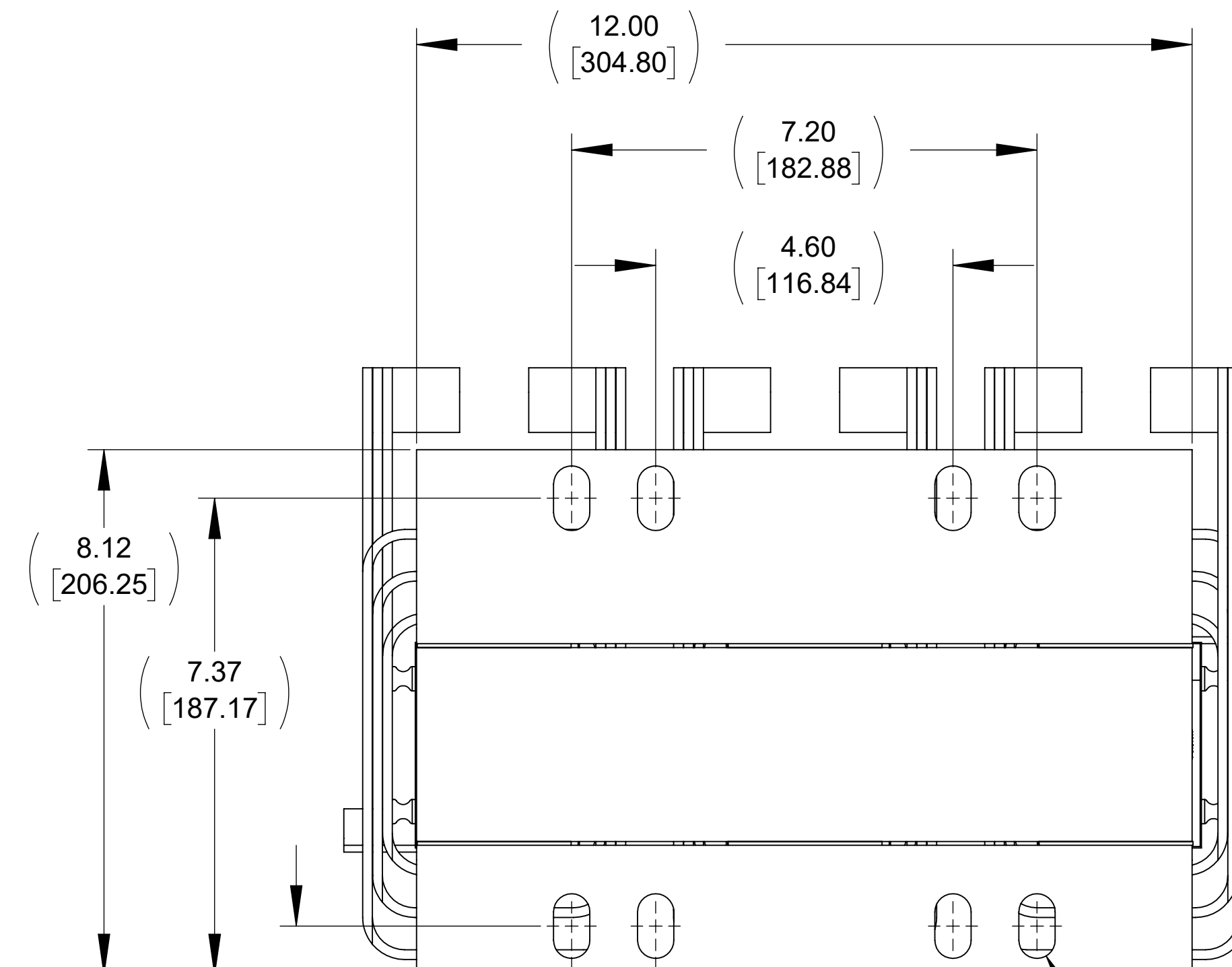

BOTTOM VIEW

$(\phi .56 [14.27] \times 1.00 [25.40])$
SLOT, 8 PLACES

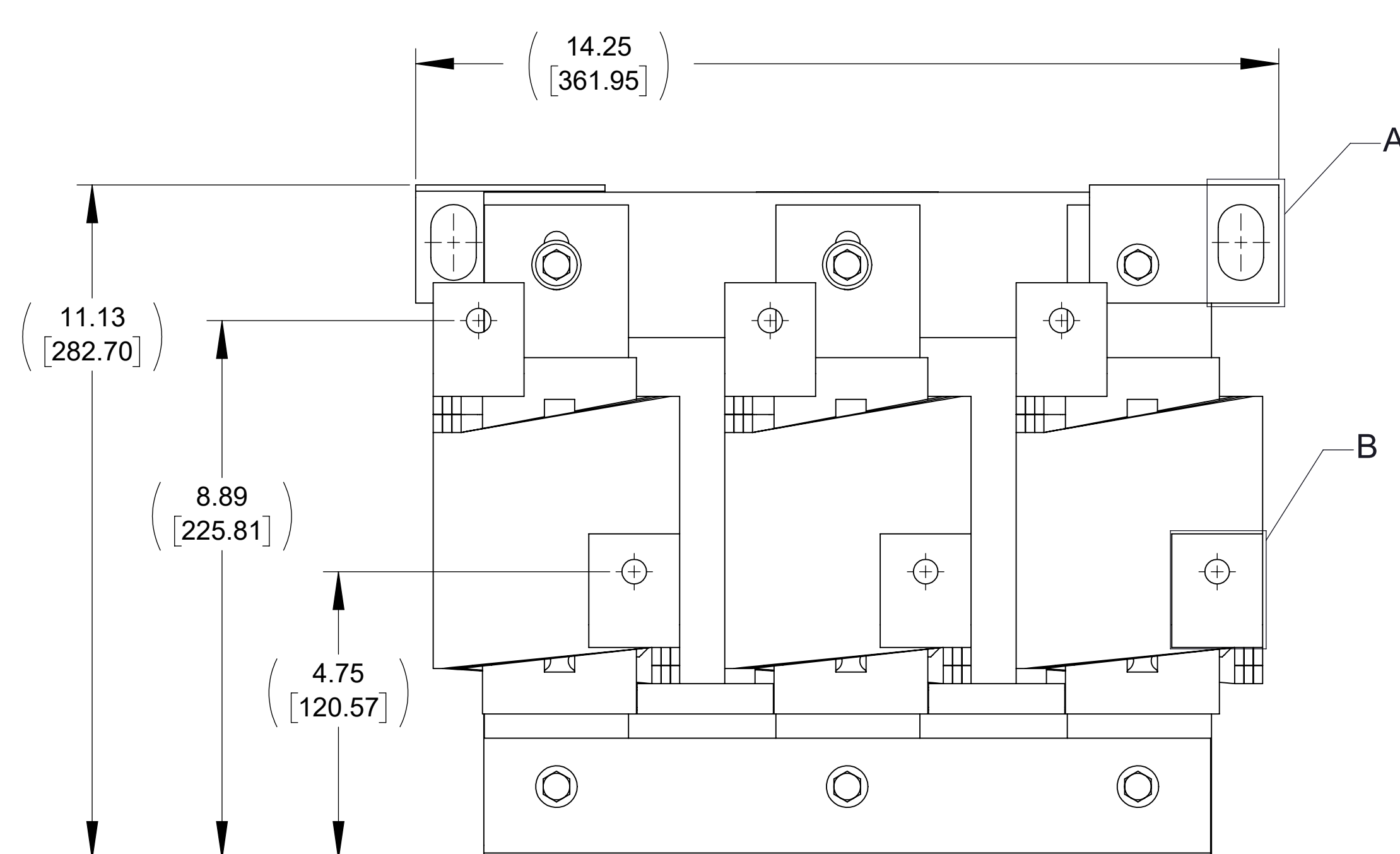

FRONT VIEW

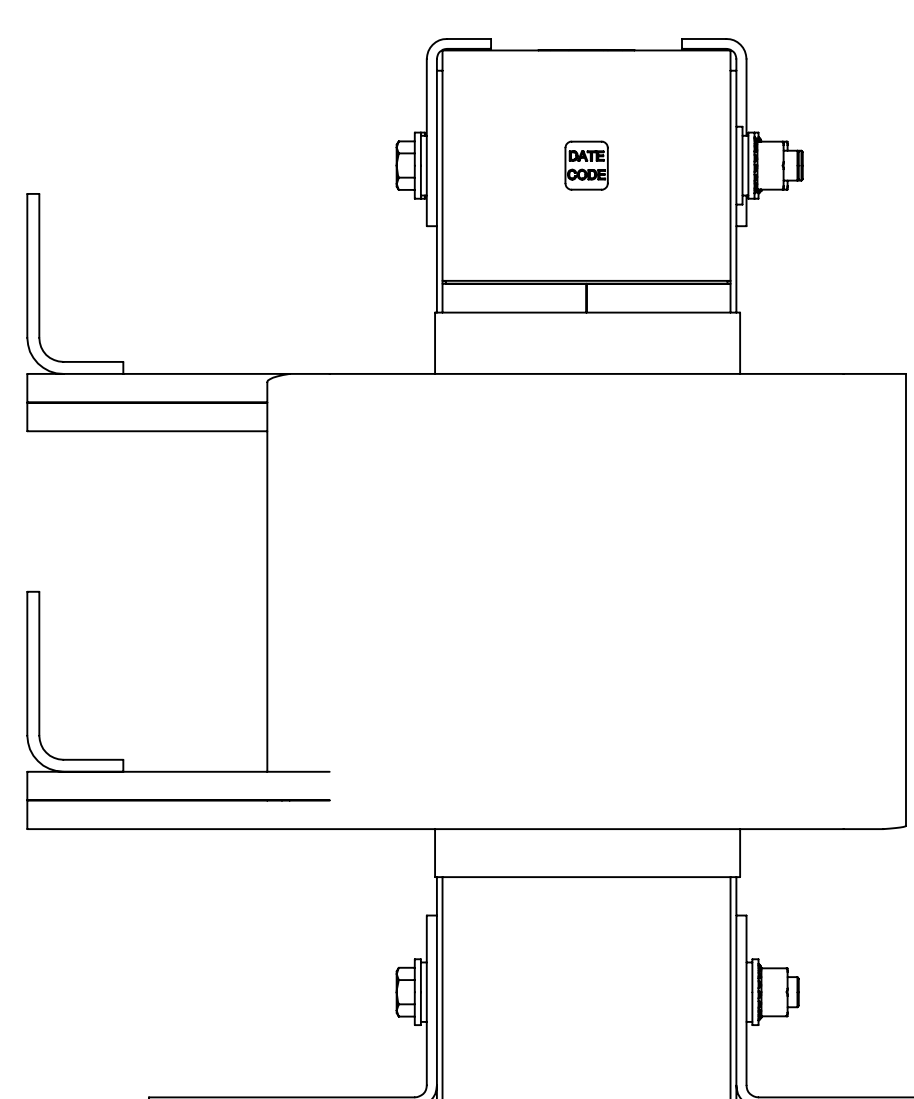

SIDE VIEW

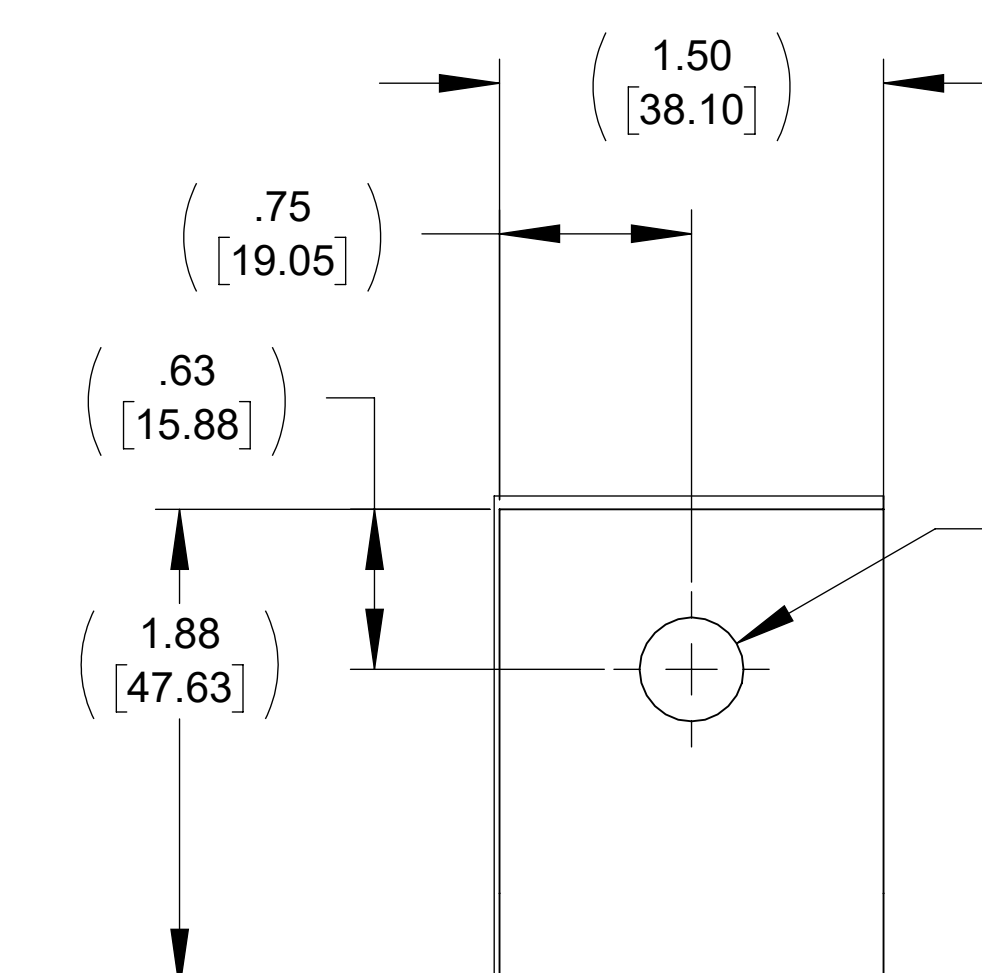

DETAIL B (6 PLACES)

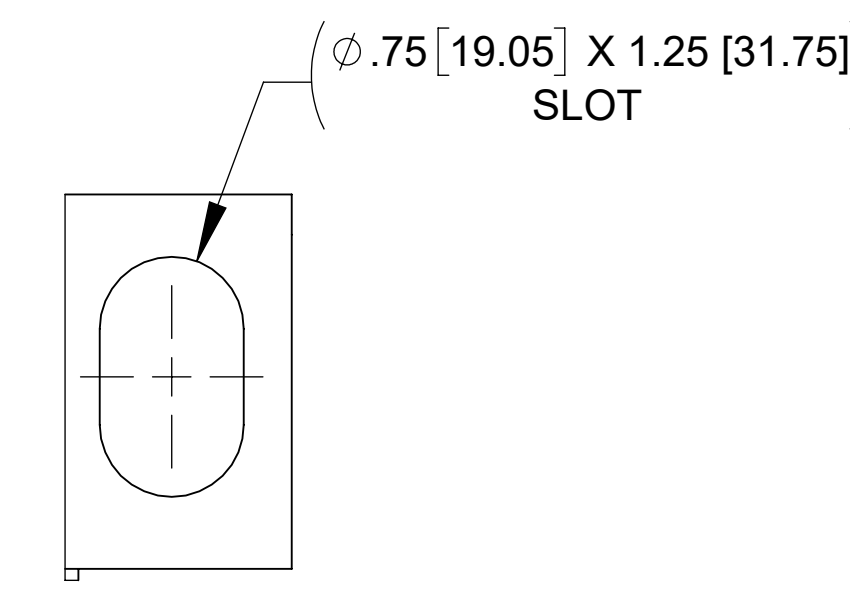

DETAIL A (2 PLACES)

NOTES:

1. REFER TO USER MANUAL FOR COMPLETE INSTALLATION INSTRUCTIONS.

THE COMPONENT, PART OR ASSEMBLY DESCRIBED IN THIS DOCUMENT MUST COMPLY WITH THE EU (EUROPEAN UNION) DIRECTIVE RoHS2 CONTAINS <0.1% OF ANY SVHC BY WEIGHT PER REACH REGULATION		MATERIAL		CONFIDENTIAL AND PROPRIETARY INFORMATION THIS DOCUMENT CONTAINS CONFIDENTIAL AND PROPRIETARY INFORMATION OF MTE CORPORATION AND MAY NOT BE USED, COPIED OR DISCLOSED TO OTHERS EXCEPT WITH THE AUTHORIZED WRITTEN PERMISSION OF MTE CORPORATION	
UNLESS OTHERWISE SPECIFIED DIMENSIONS ARE IN INCHES [MM] TOLERANCES ARE: ANGLES: $\pm 1^\circ$ 1 PLACE .X: $\pm .1 [2.5]$ 2 PLACE .XX: $\pm .03 [0.76]$ 3 PLACE .XXX: $\pm .010 [0.254]$				DESCRIPTION LINE/LOAD REACTOR (400A 0.60mH)	
DRAWN WF	DATE 01/22/20	CHECKED WF	DATE 01/23/20	SIZE D	DWG No. CD 1321-3RB400-B
APPROVED PY	DATE 01/24/20	SCALE 1:2		REV 00	SHEET 1 OF 1