

1

2

3

4

5

6

7

8

TERMINAL COVER HIGH ASSEMBLY

ITEM	DESCRIPTION	QTY	AB CAT NUMBER
1	MOLDED CASE CIRCUIT BREAKER	1	140-I-4P CB
2	TERMINAL COVER HIGH	2	140G-I-TC4H

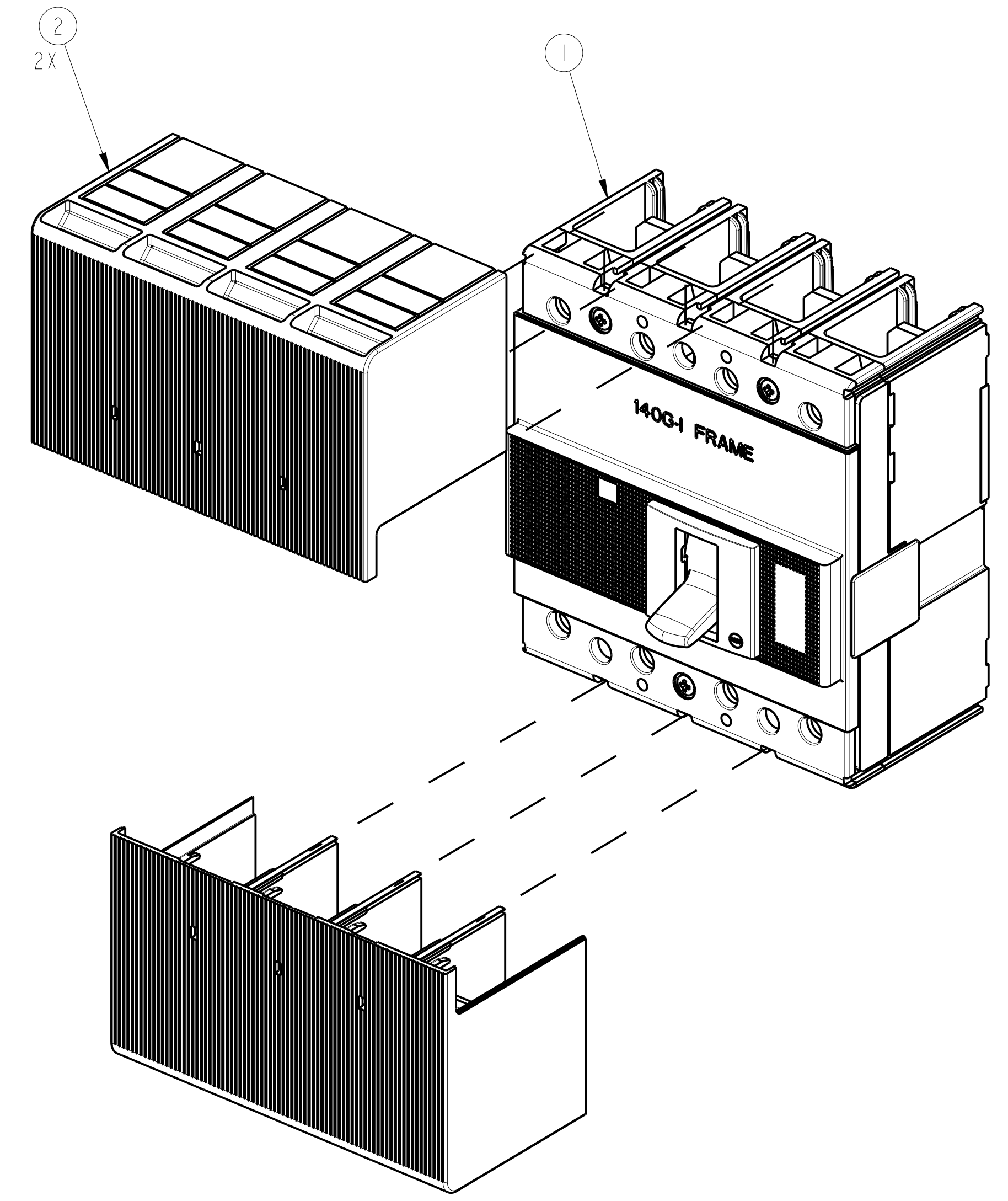
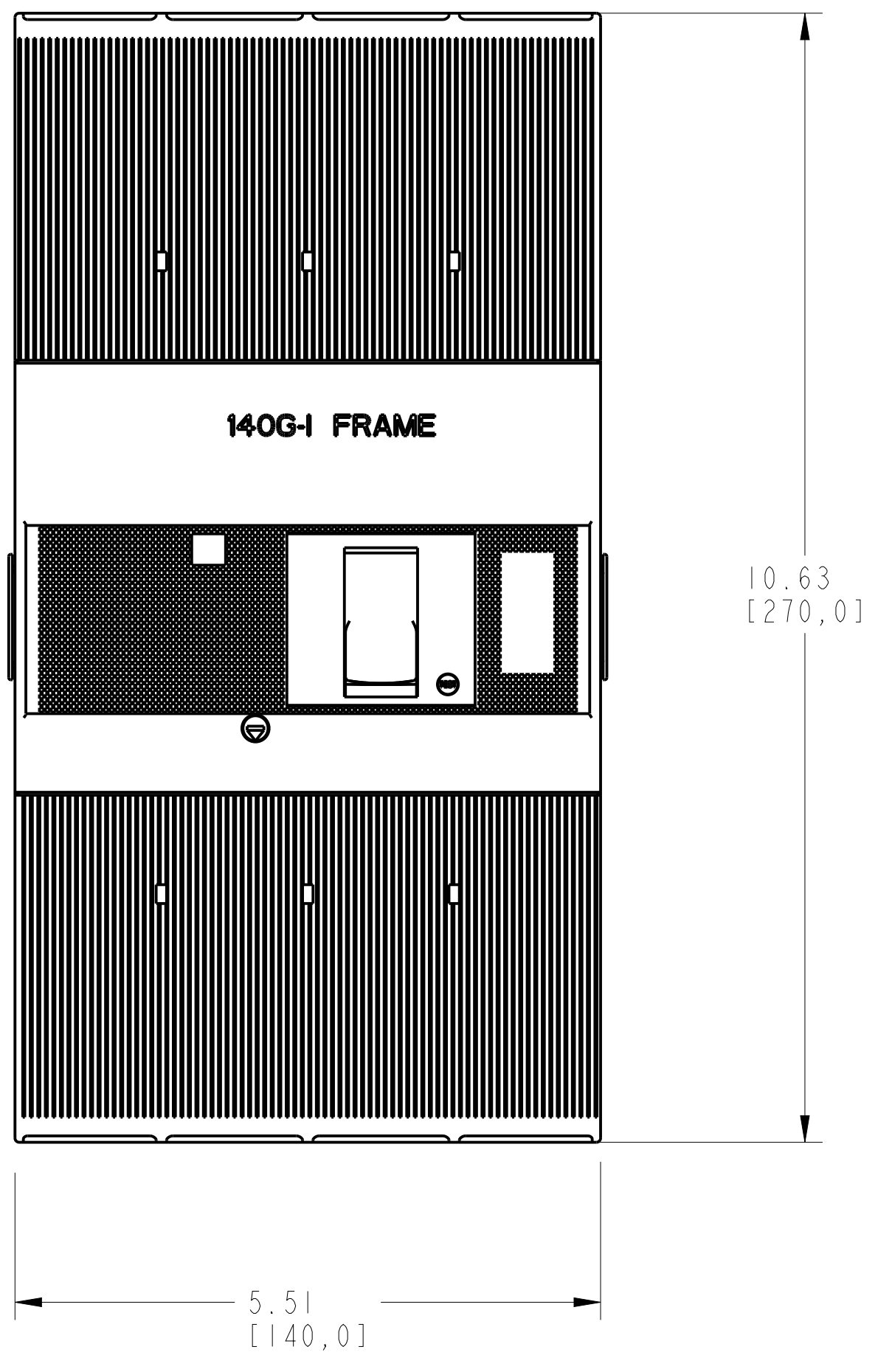
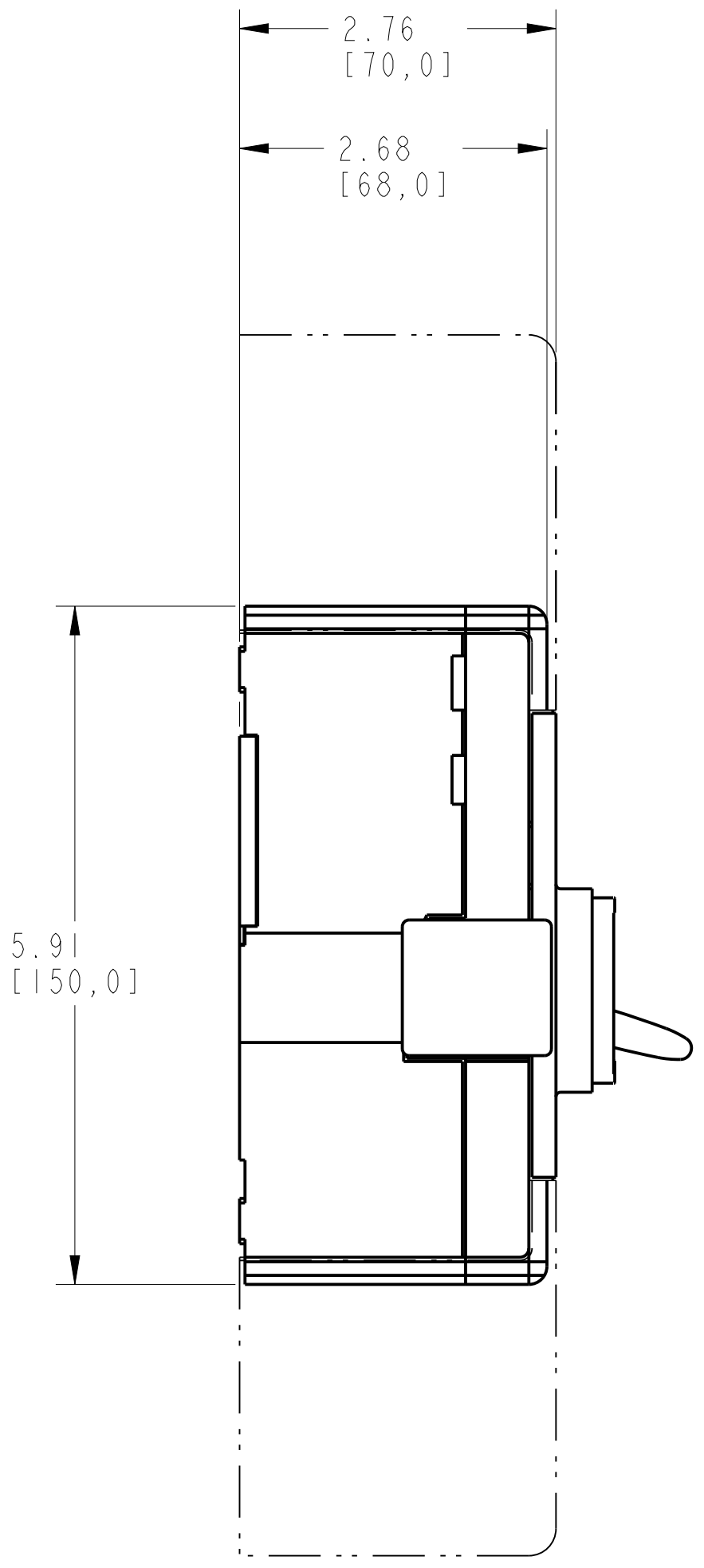
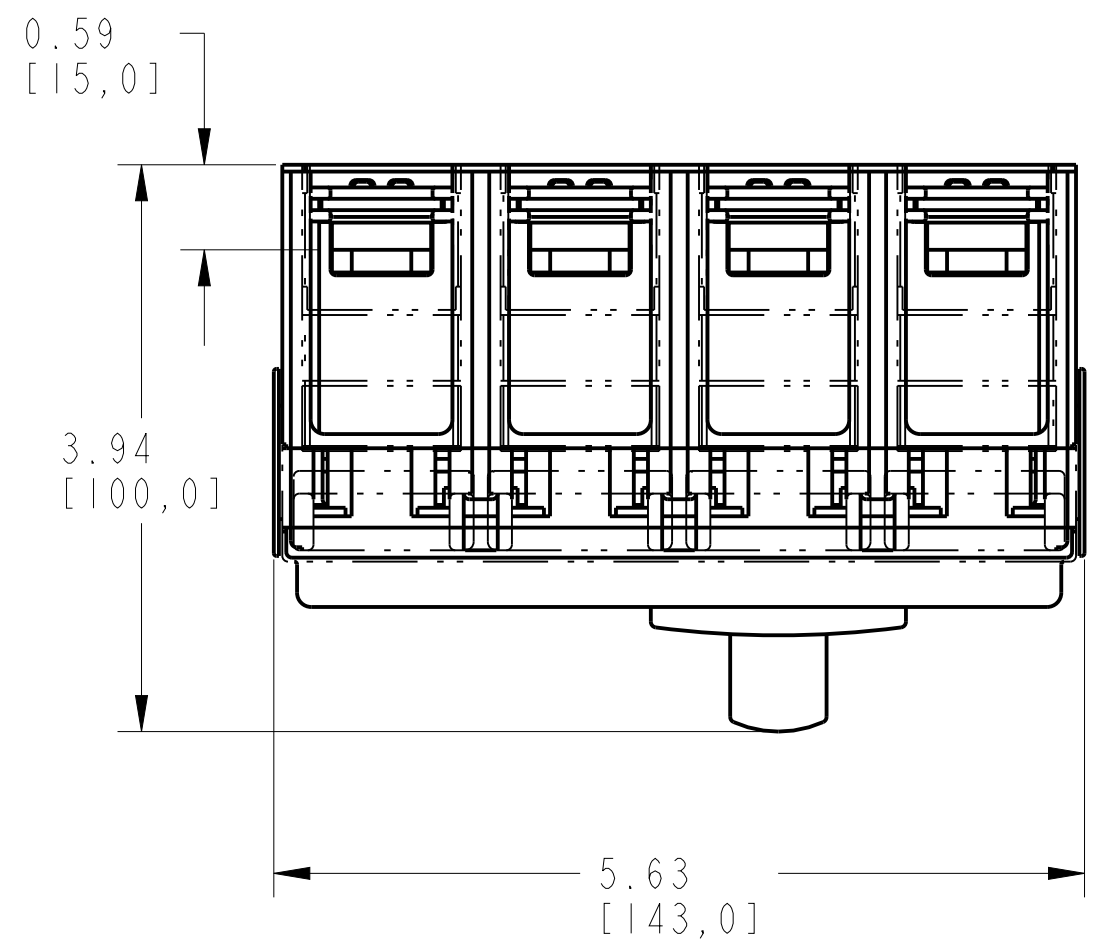

TERMINAL COVER HIGH ASSEMBLED TO 140-I-4-POLE  
SCALE 0.75:1

**Rockwell Automation**

TC-HIGH ASSEMBLED TO 140-I-4P CB

Drawn by: UMUNUSW

Date: 10-18-13

CONFIDENTIAL AND PROPRIETARY INFORMATION  
THIS DOCUMENT CONTAINS CONFIDENTIAL AND PROPRIETARY  
INFORMATION OF ROCKWELL AUTOMATION, INC. AND MAY  
NOT BE USED, COPIED OR DISCLOSED TO OTHERS, EXCEPT  
WITH THE AUTHORIZED WRITTEN PERMISSION OF ROCKWELL  
AUTOMATION, INC.

Sheet 1 Of 2

10000851866

00

1 2 3 4 5 6 7 8

A  
B  
C  
D  
E  
F  
G  
H

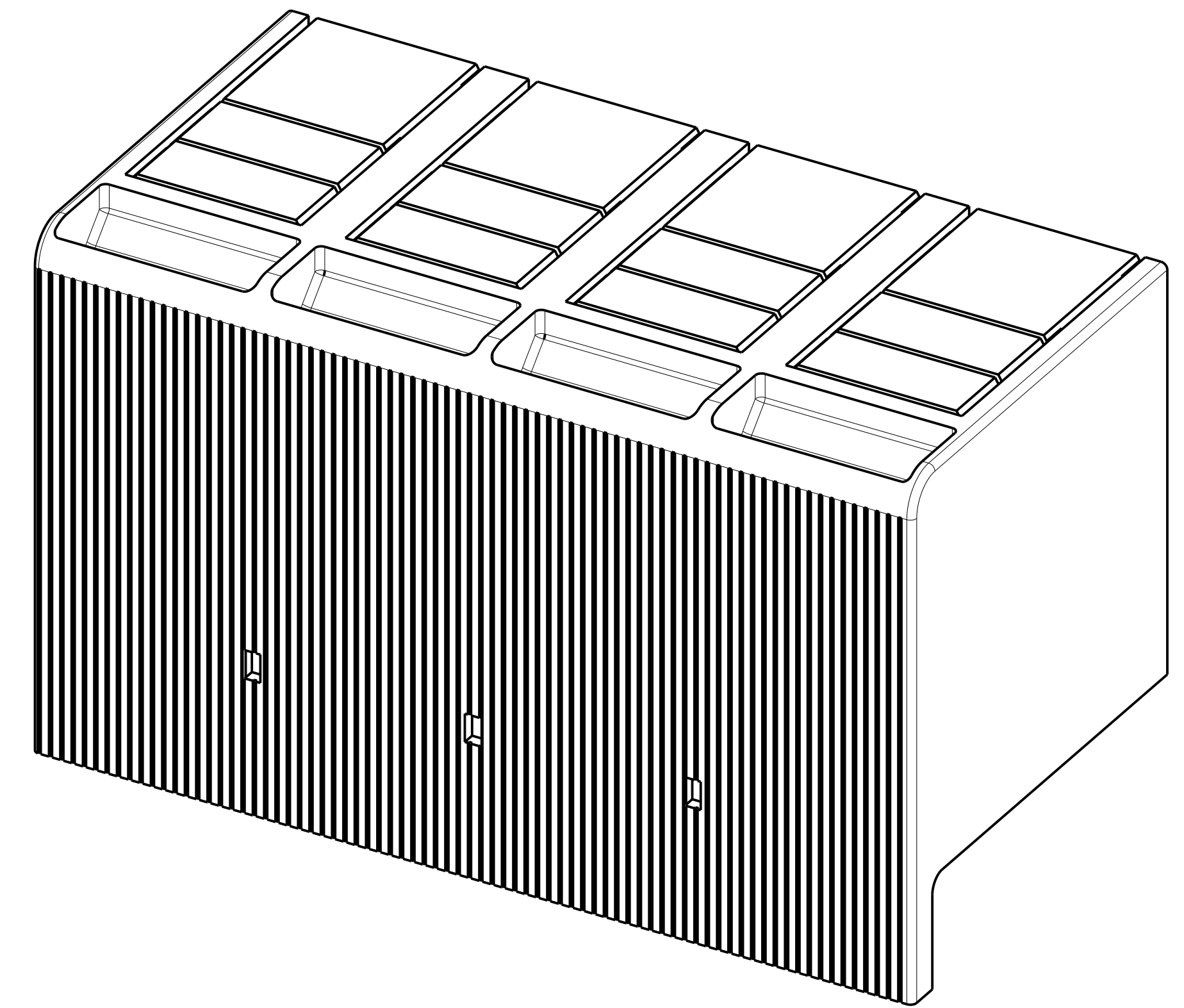
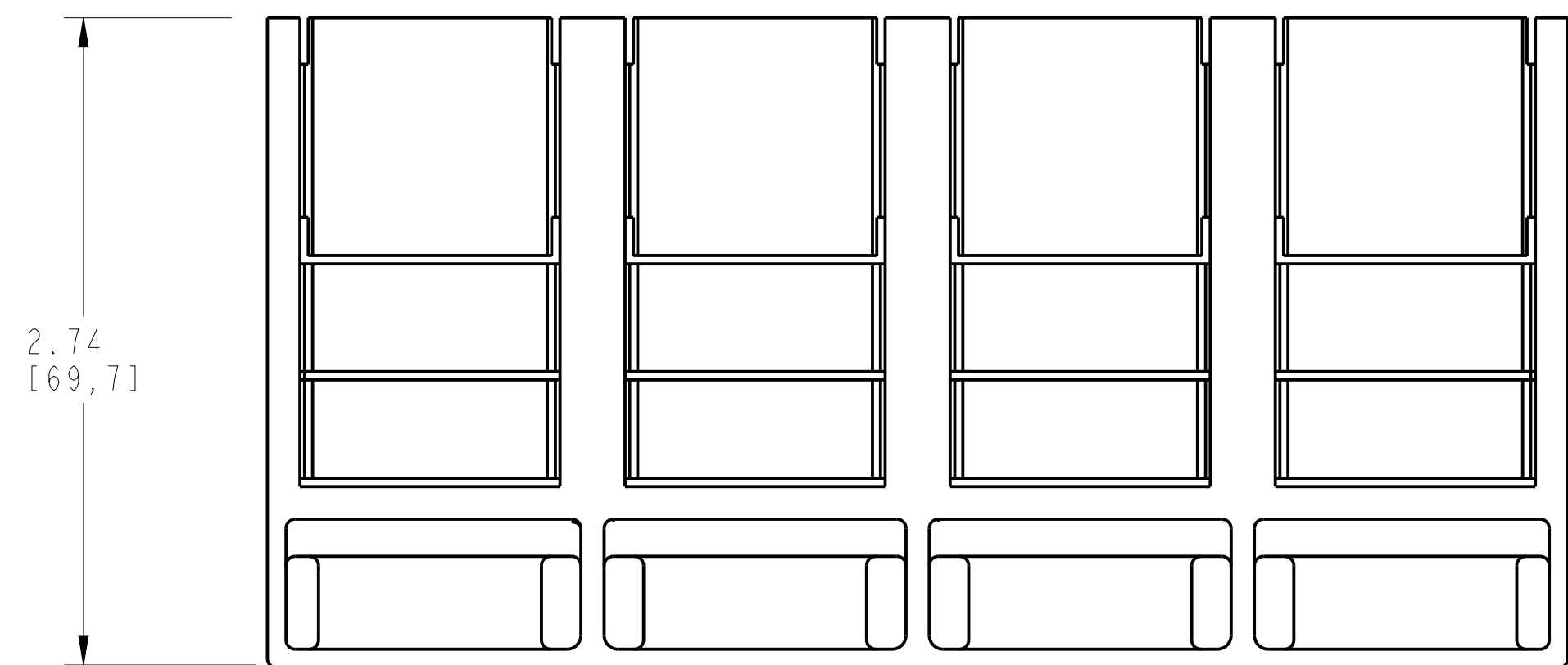

ISOMETRIC VIEW

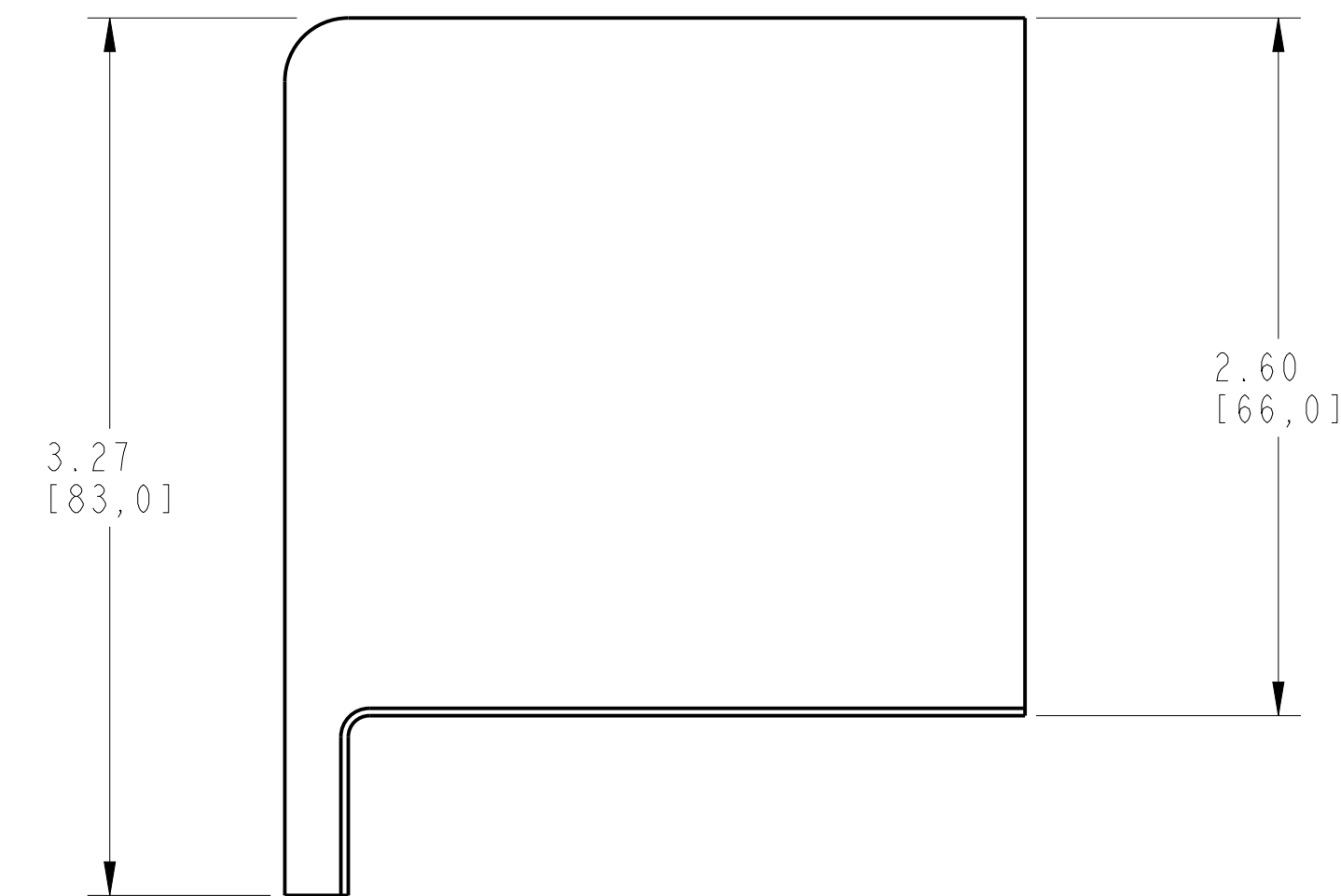
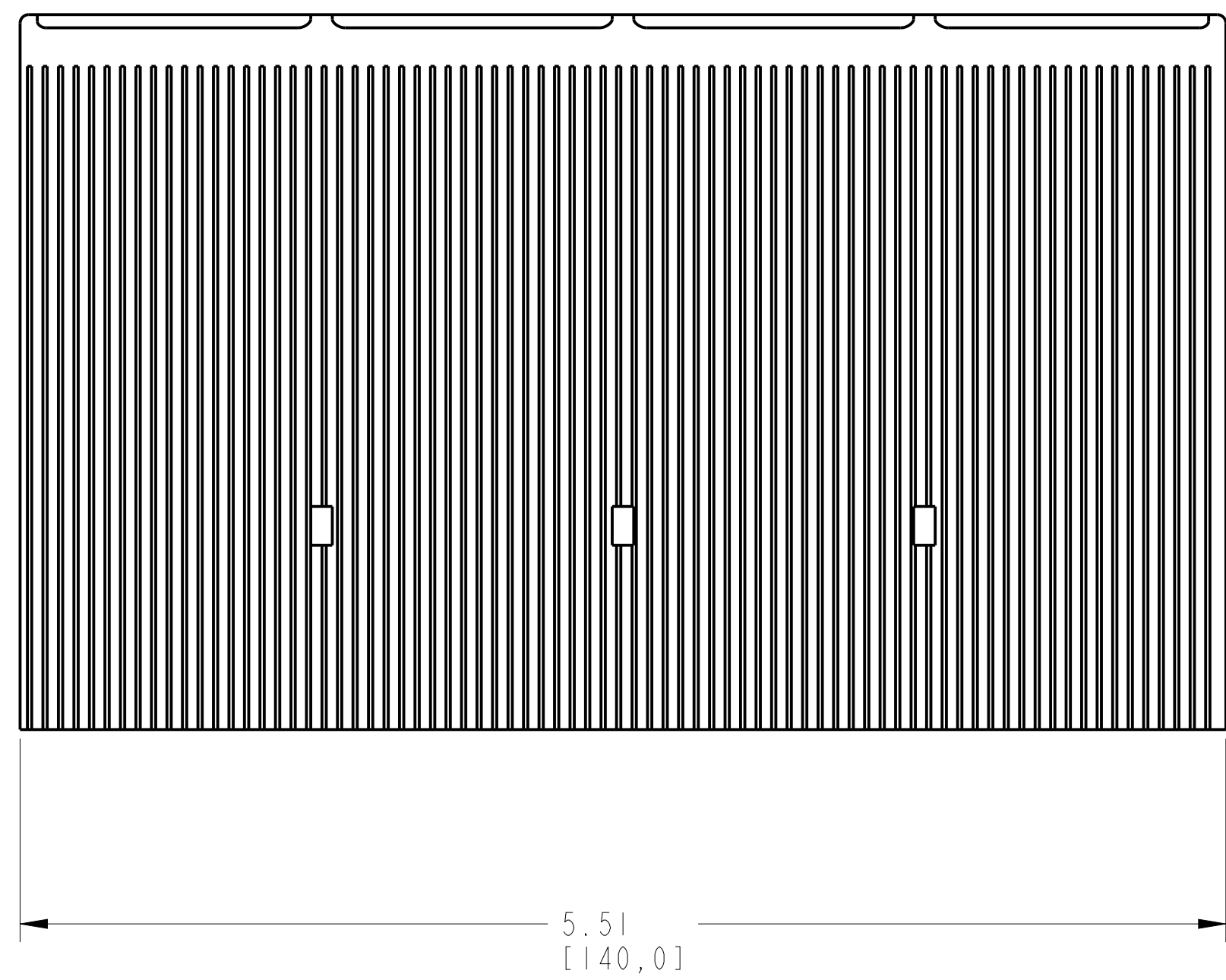

ITEM 2 : TERMINAL COVER HIGH  
SCALE 1.5:1

		<small>CONFIDENTIAL AND PROPRIETARY INFORMATION. THIS DOCUMENT CONTAINS CONFIDENTIAL AND PROPRIETARY INFORMATION OF ROCKWELL AUTOMATION, INC. AND MAY NOT BE USED, COPIED OR DISCLOSED TO OTHERS, EXCEPT WITH THE AUTHORIZED WRITTEN PERMISSION OF ROCKWELL AUTOMATION, INC.</small>	
		Sheet 2 Of 2	
TC-HIGH ASSEMBLED TO 140-I-4P CB		Size <b>D</b>	Ver <b>00</b>
Drawn by: UMUNUSW	Date: 10-18-13	10000851866	