

TERMINAL COVER LOW ASSEMBLY			
ITEM	DESCRIPTION	QTY	AB CAT NUMBER
1	MOLDED CASE CIRCUIT BREAKER	1	140G-M-4P CB
2	TERMINAL COVER LOW	2	140G-M-TC4L

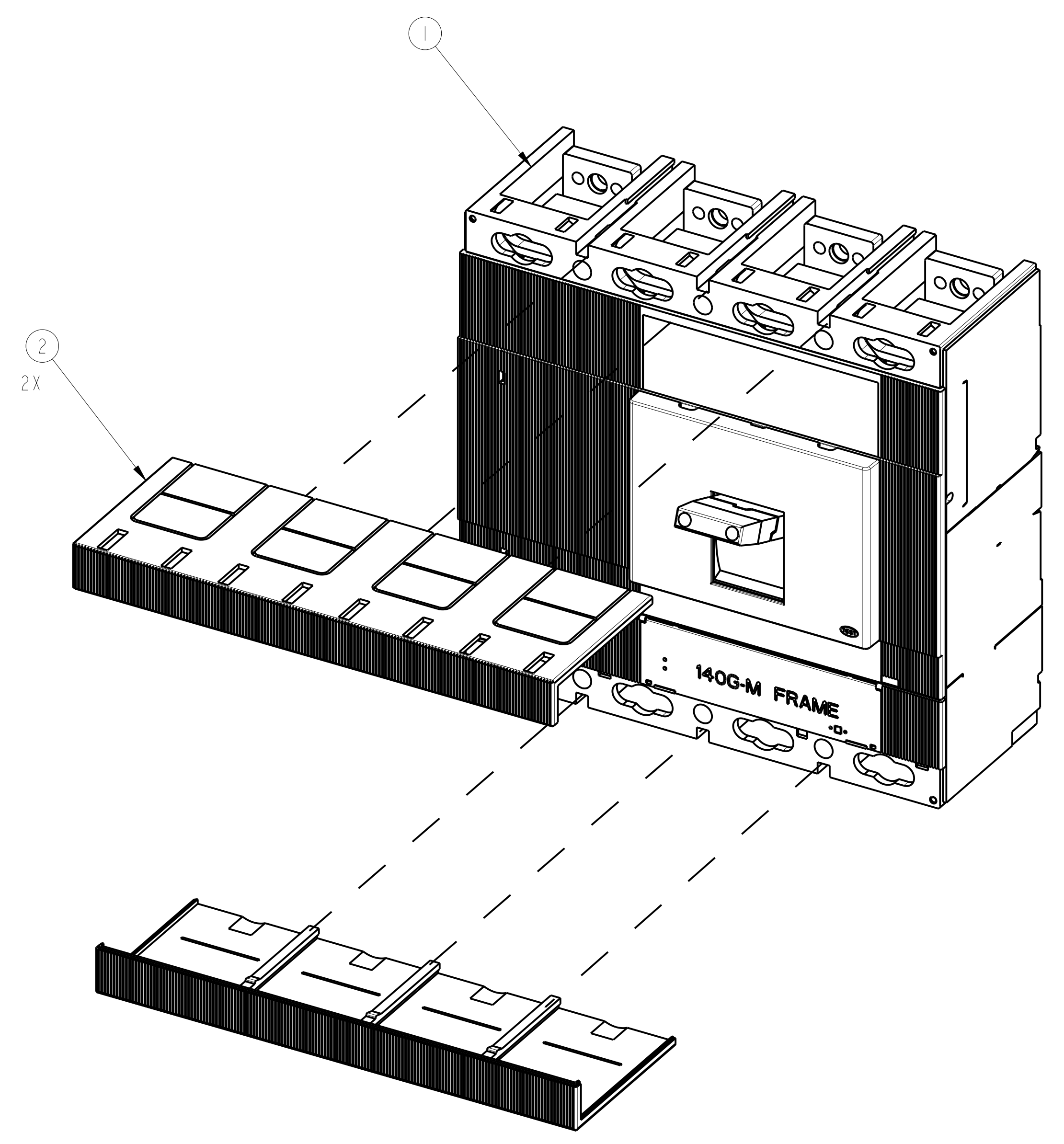

TERMINAL COVER LOW ASSEMBLED TO 140G-M-4-POLE
SCALE 0.55:1

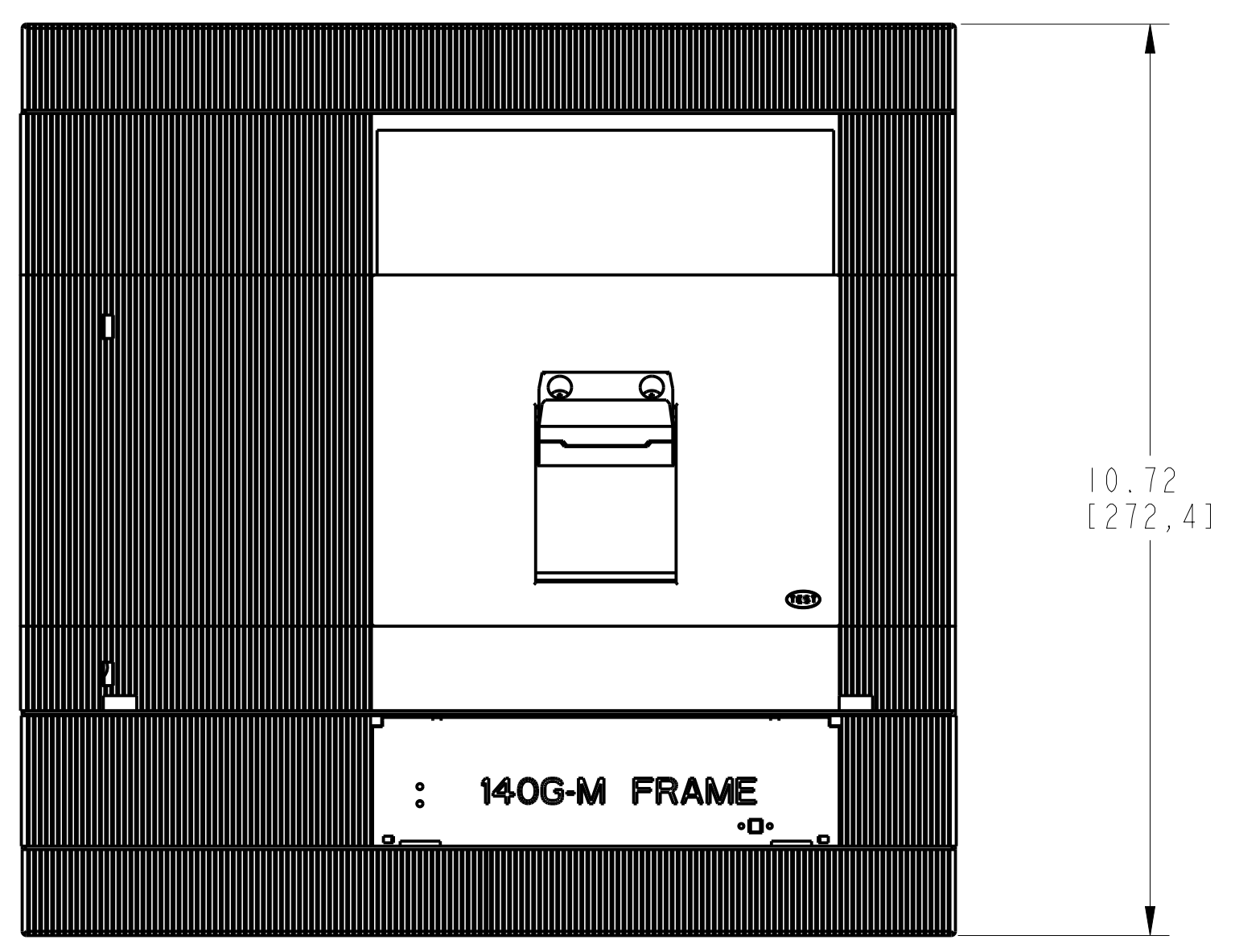
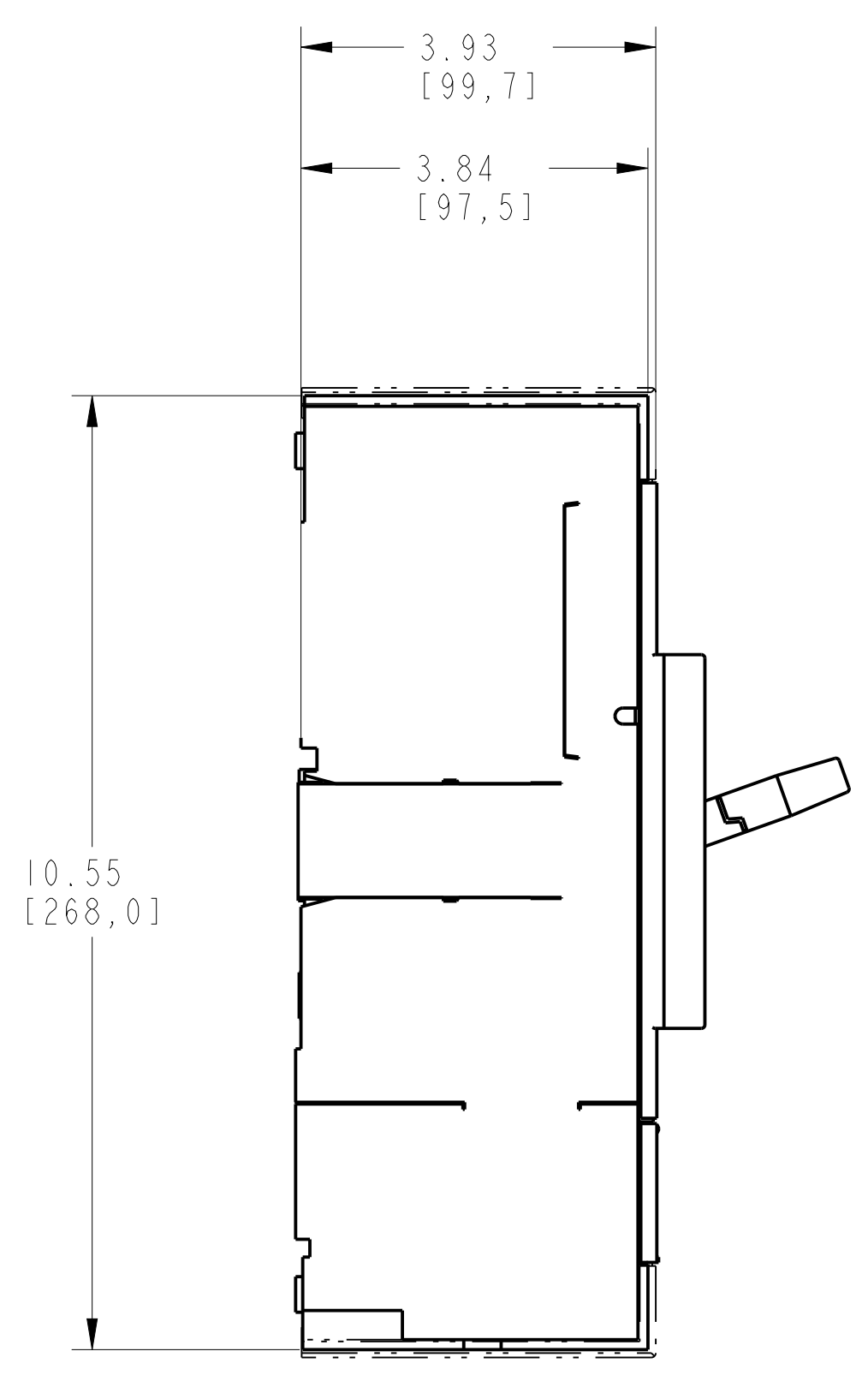
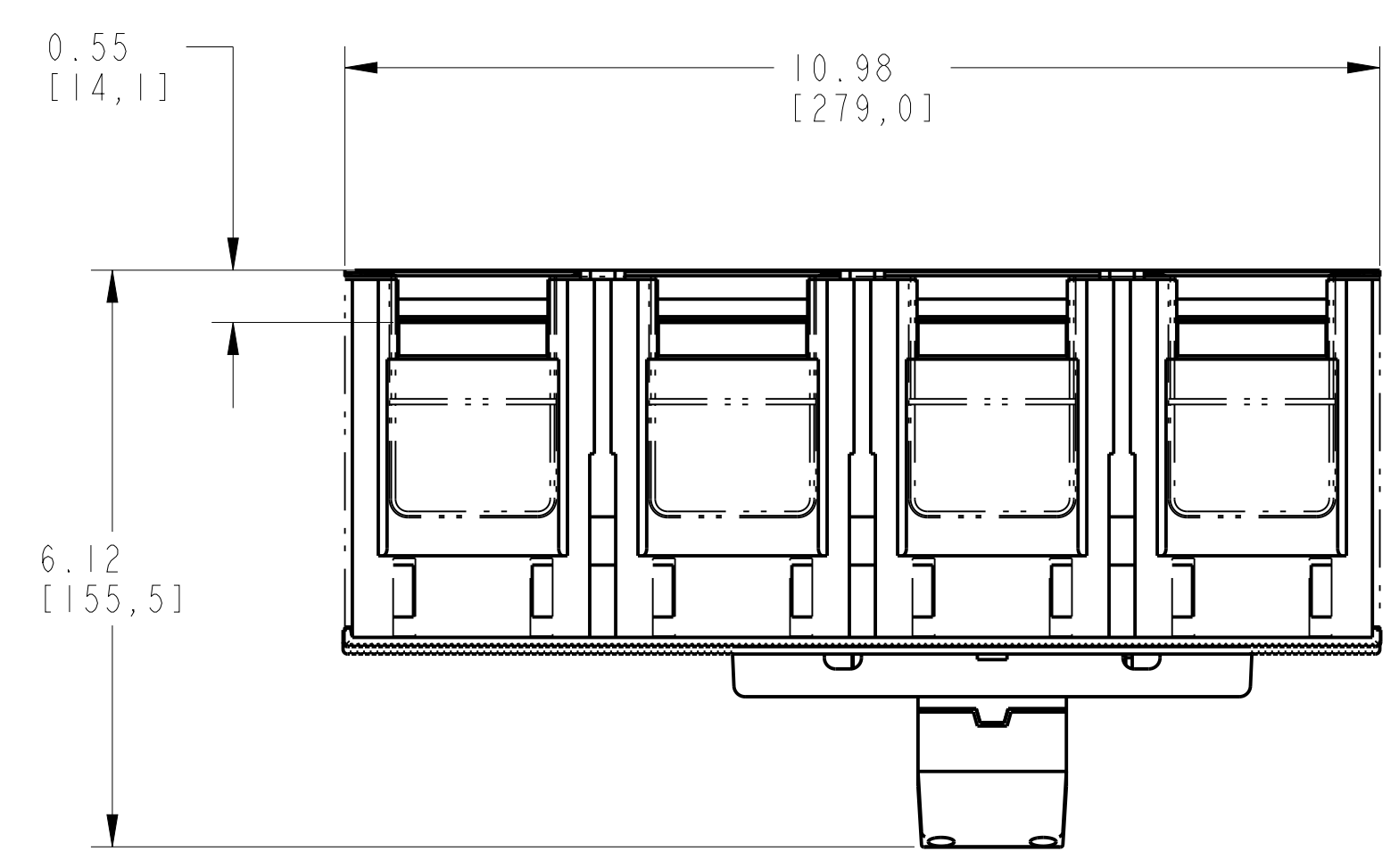
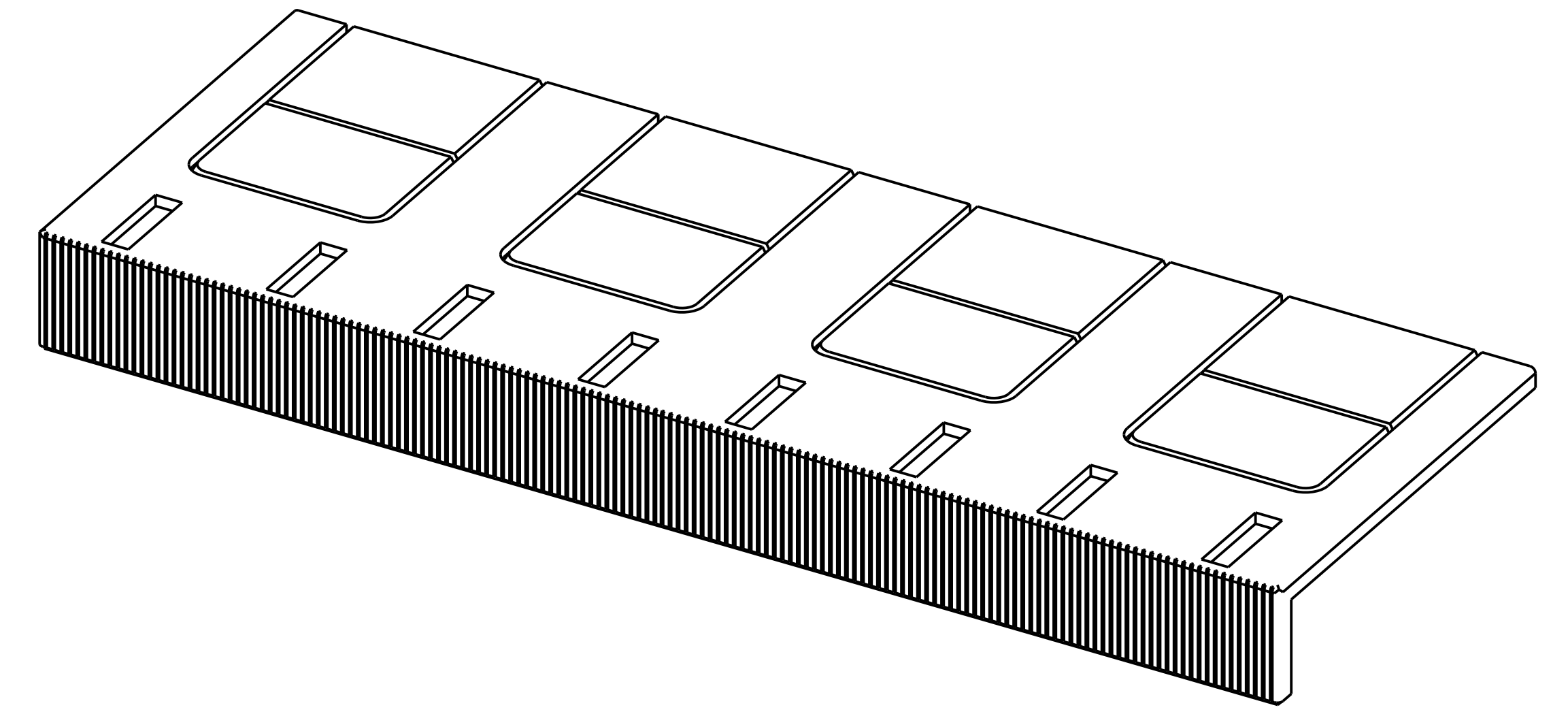
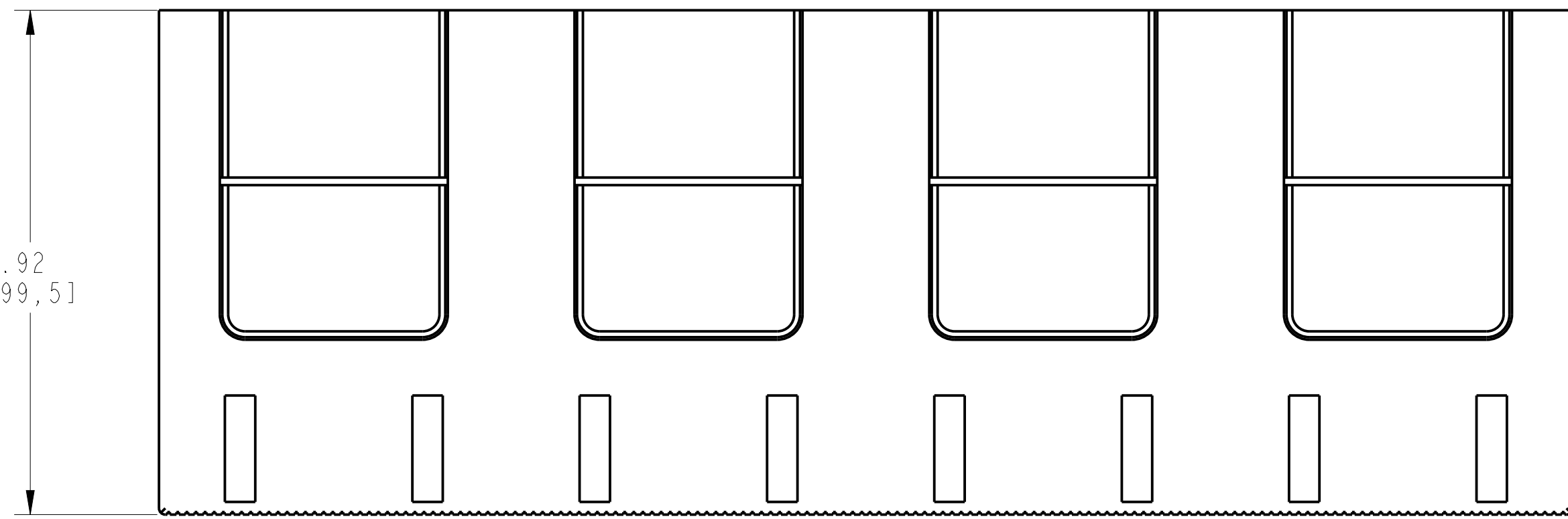

ISOMETRIC VIEW

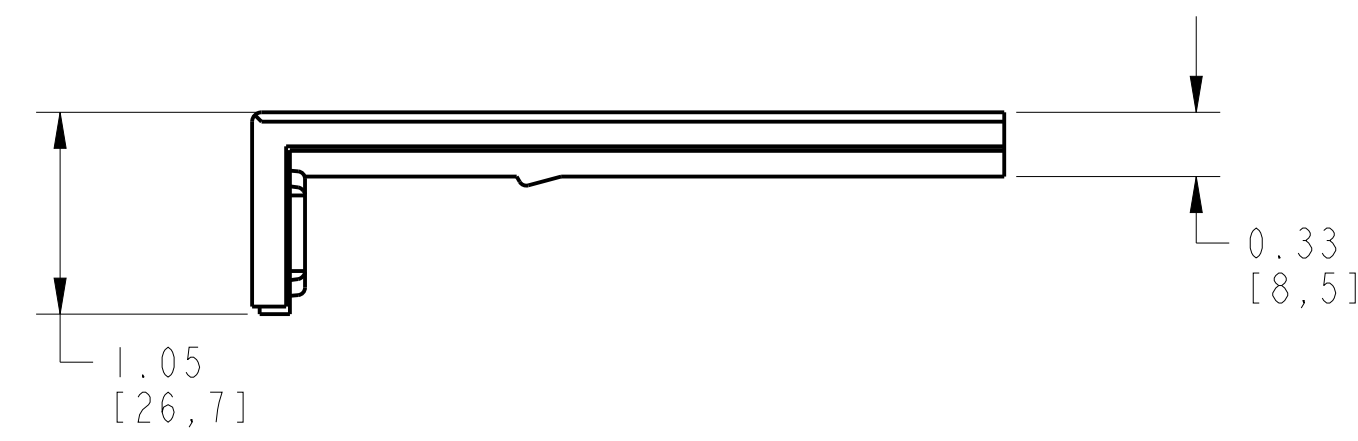
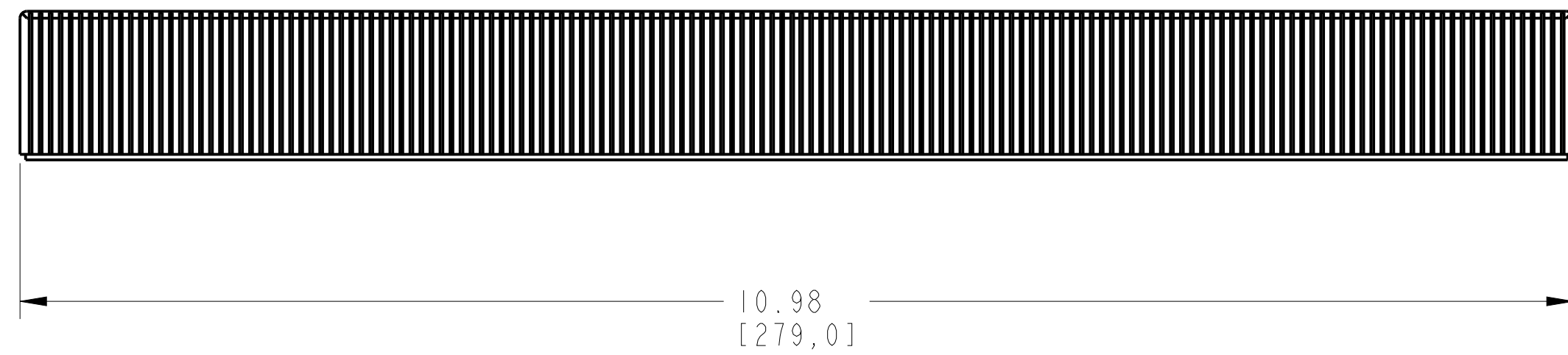

ITEM 2 : TERMINAL COVER LOW
SCALE 1:1

		<small>CONFIDENTIAL AND PROPRIETARY INFORMATION THIS DOCUMENT CONTAINS CONFIDENTIAL AND PROPRIETARY INFORMATION OF ROCKWELL AUTOMATION, INC. AND MAY NOT BE USED, COPIED OR DISCLOSED TO OTHERS, EXCEPT WITH THE AUTHORIZED WRITTEN PERMISSION OF ROCKWELL AUTOMATION, INC.</small>	
		Sheet 2 Of 2	
TC-LOW ASSEMBLED TO 140G-M-4POLE CB		Size D	Ver 00
Drawn by: UMUNUSW	Date: OCT-17-2013	1000850999	