

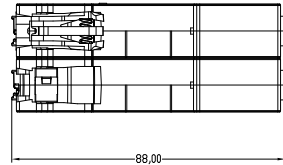

D-D

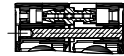

88,00



C-C

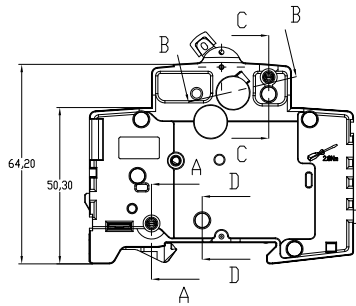
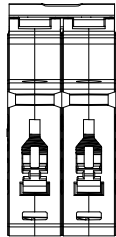

64,20

50,30

A

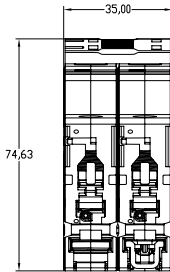

35,00

74,63

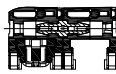
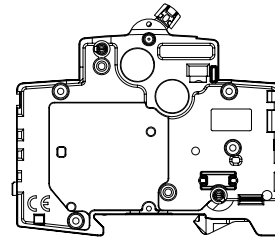

A-A

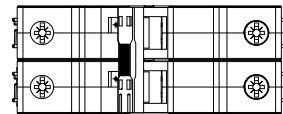

B-B

		C630-N	PN-DI65444
		C500-N	PN-DI65442
		C400-N	PN-DI65440
		C320-N	PN-DI65438
		C300-N	PN-DI65436
		C250-N	PN-DI65434
		C200-N	PN-DI65432
		C160-N	PN-DI65430
		C150-N	PN-DI65428
		C130-N	PN-DI65426
		C100-N	PN-DI65424
		C080-N	PN-DI65422
		C070-N	PN-DI65420
		C060-N	PN-DI65418
		C050-N	PN-DI65416
		C040-N	PN-DI65414
		C030-N	PN-DI65412
		C020-N	PN-DI65410
		C010-N	PN-DI65408
		C005-N	PN-DI65406
D630-N	PN-DI65484	B630-N	PN-DI65404
D500-N	PN-DI65482	B500-N	PN-DI65402
D400-N	PN-DI65480	B400-N	PN-DI65400
D320-N	PN-DI65478	B320-N	PN-DI65398
D300-N	PN-DI65476	B300-N	PN-DI65396
D250-N	PN-DI65474	B250-N	PN-DI65394
D200-N	PN-DI65472	B200-N	PN-DI65392
D160-N	PN-DI65470	B160-N	PN-DI65390
D150-N	PN-DI65468	B150-N	PN-DI65388
D130-N	PN-DI65466	B130-N	PN-DI65386
D100-N	PN-DI65464	B100-N	PN-DI65384
D080-N	PN-DI65462	B080-N	PN-DI65382
D070-N	PN-DI65460	B070-N	PN-DI65380
D060-N	PN-DI65458	B060-N	PN-DI65378
D050-N	PN-DI65456	B050-N	PN-DI65376
D040-N	PN-DI65454	B040-N	PN-DI65374
D030-N	PN-DI65452	B030-N	PN-DI65372
D020-N	PN-DI65450	B020-N	PN-DI65370
D010-N	PN-DI65448	B010-N	PN-DI65368
D005-N	PN-DI65446	B005-N	PN-DI67842
CATALOG NUMBER	MATERIAL MASTER	CATALOG NUMBER	MATERIAL MASTER

**Rockwell Automation**

CONFIDENTIAL AND PROPRIETARY INFORMATION.  
THIS DOCUMENT CONTAINS CONFIDENTIAL AND PROPRIETARY INFORMATION OF ROCKWELL AUTOMATION, INC. AND MAY NOT BE USED, COPIED OR DISCLOSED TO OTHERS, EXCEPT WITH THE AUTHORIZED WRITTEN PERMISSION OF ROCKWELL AUTOMATION, INC.

SUPPLEMENTARY PROTECTOR, 1 POLE+N  
1492-SPM1\*

Sheet 1 OF 1

Drawn by: M. GUELM

Date: 9/18/2013

Size c 10000858698

Ver 00