

1 2 3 4 5 6 7 8

A
B
C
D
E
F
G
H

A
B
C
D
E
F
G
H

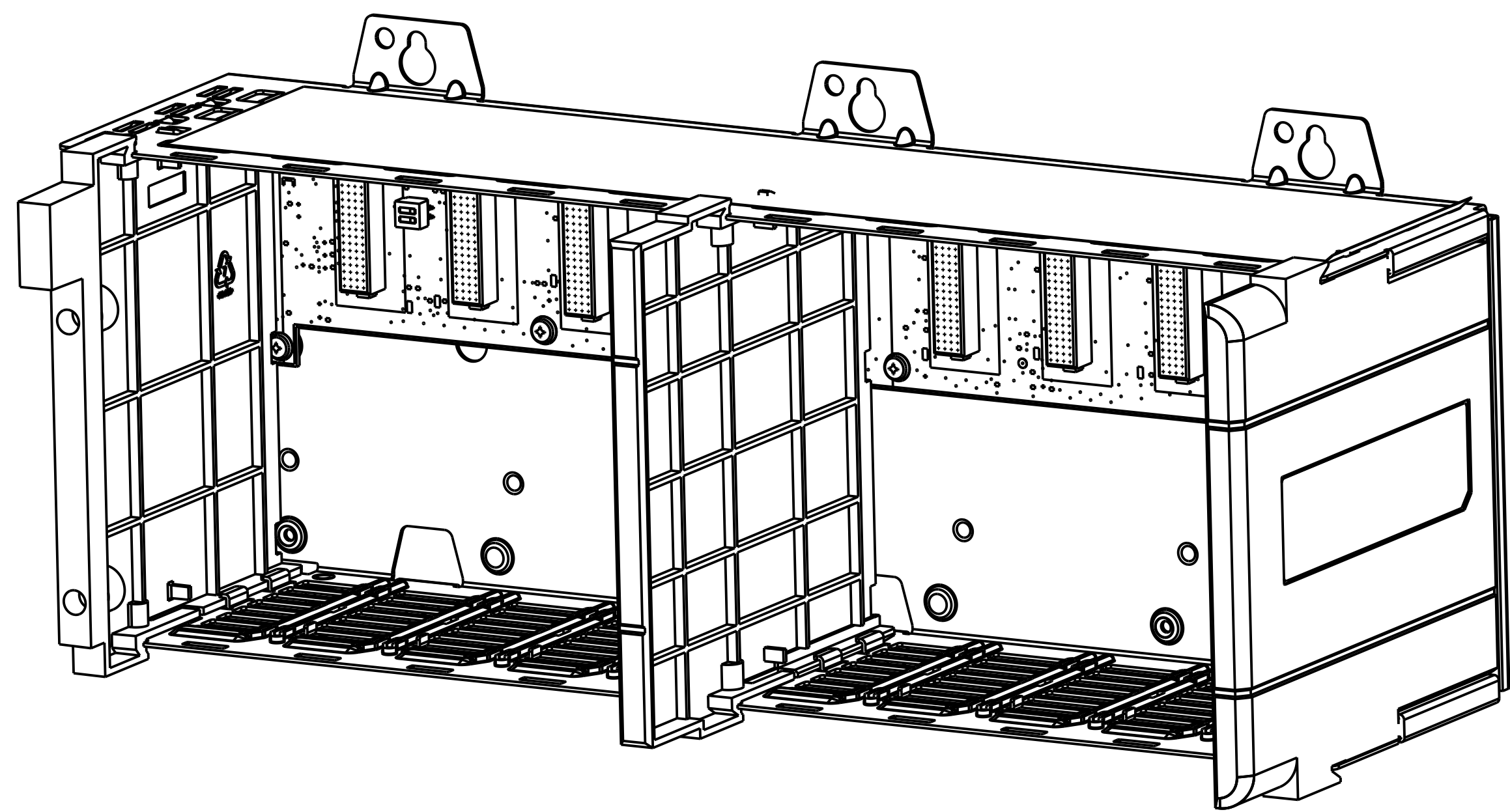
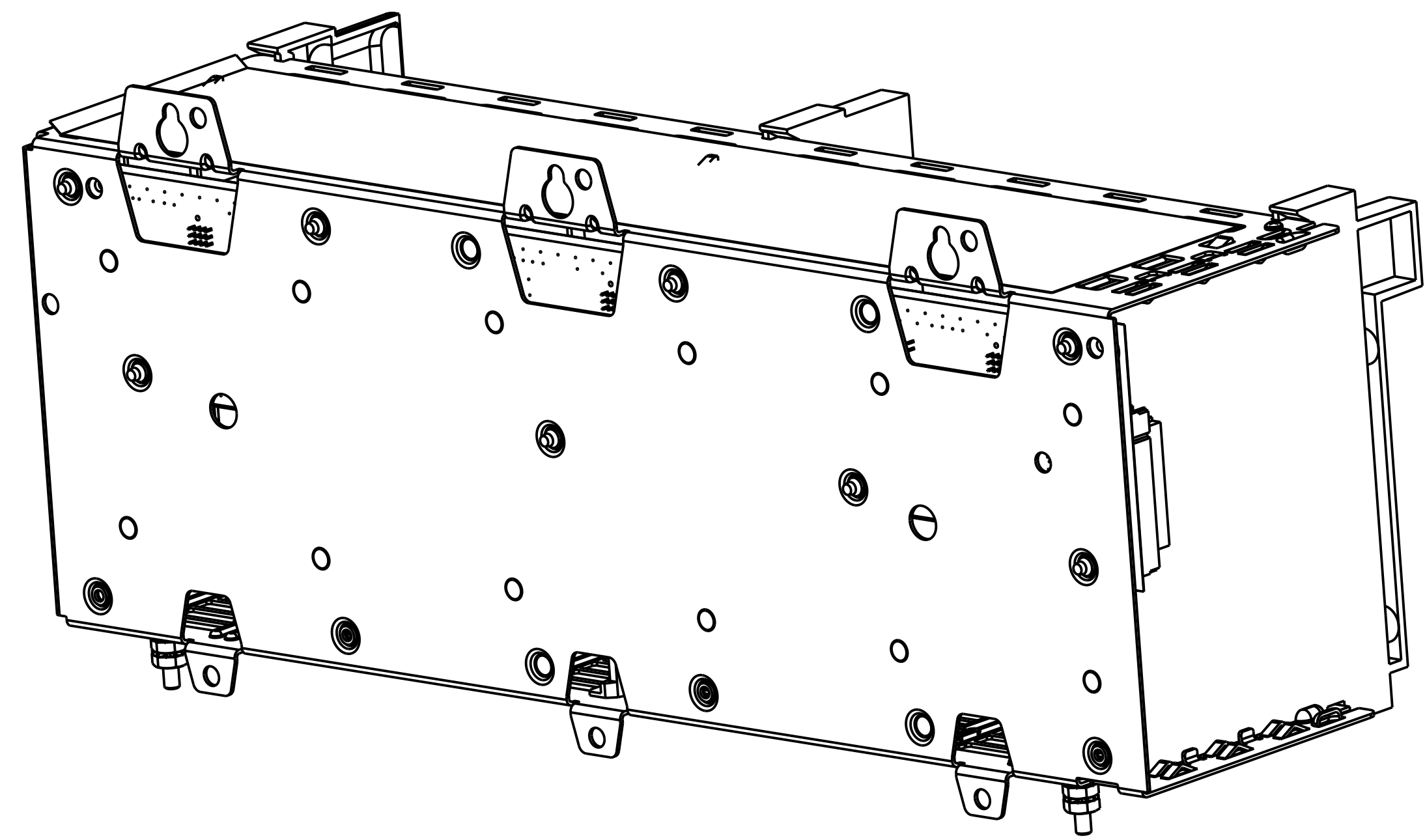

ALL UNDIMENSIONED GEOMETRIES ARE CONTROLLED BY THE CAD MODEL. IN CASE OF DIMENSION DISCREPANCY, CAD MODEL OVERRIDES.

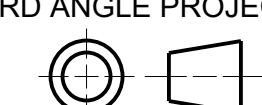

CONFIDENTIAL AND PROPRIETARY INFORMATION. THIS DOCUMENT CONTAINS CONFIDENTIAL AND PROPRIETARY INFORMATION OF ROCKWELL AUTOMATION, INC. AND MAY NOT BE USED, COPIED OR DISCLOSED TO OTHERS, EXCEPT WITH THE AUTHORIZED WRITTEN PERMISSION OF ROCKWELL AUTOMATION, INC.

THIRD ANGLE PROJECTION

DESCRIPTION
CAT 1756-A10 C CUSTOMER DRAWING

DATE: 2018-08-23	SHEET 1 OF 2
SIZE: D	VER: 01

CREATED BY: WBF CHANGED BY: *****

1 2 3 4 5 6 7 8

1 2 3 4 5 6 7 8

A
B
C
D
E
F
G
H

A
B
C
D
E
F
G
H

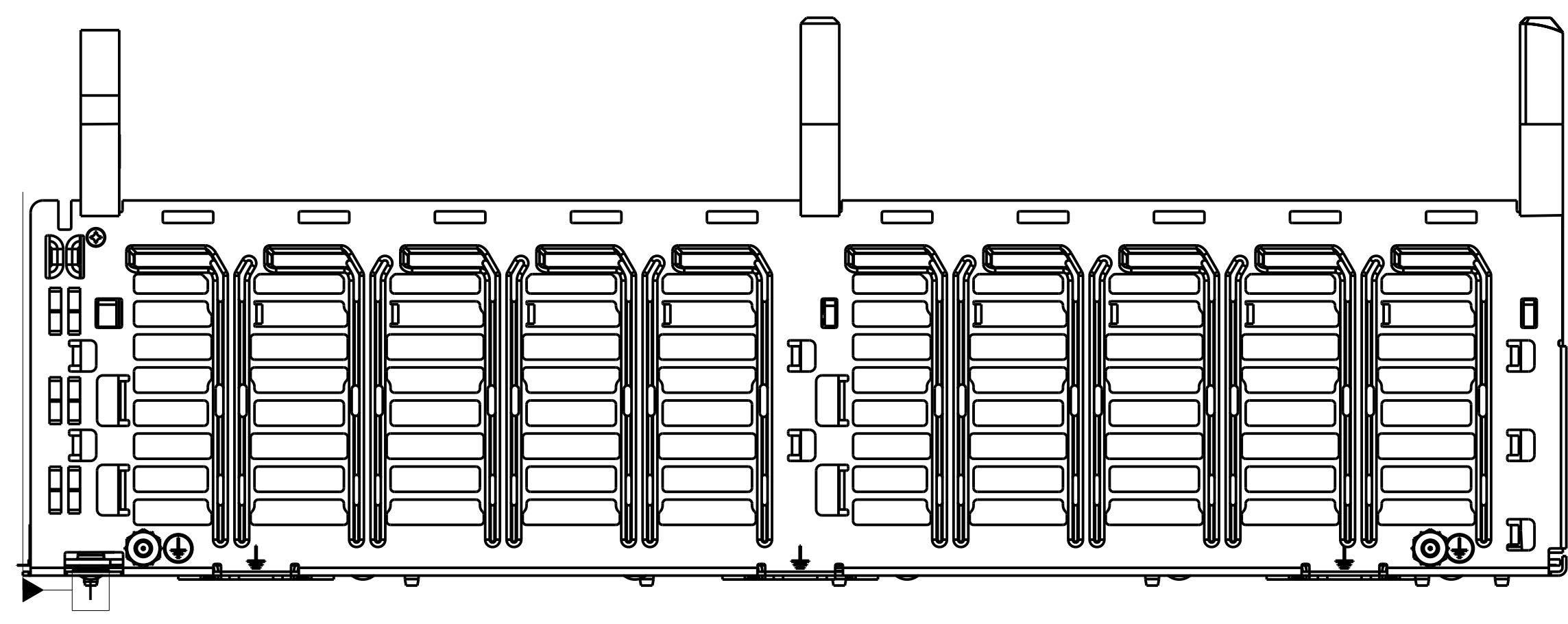
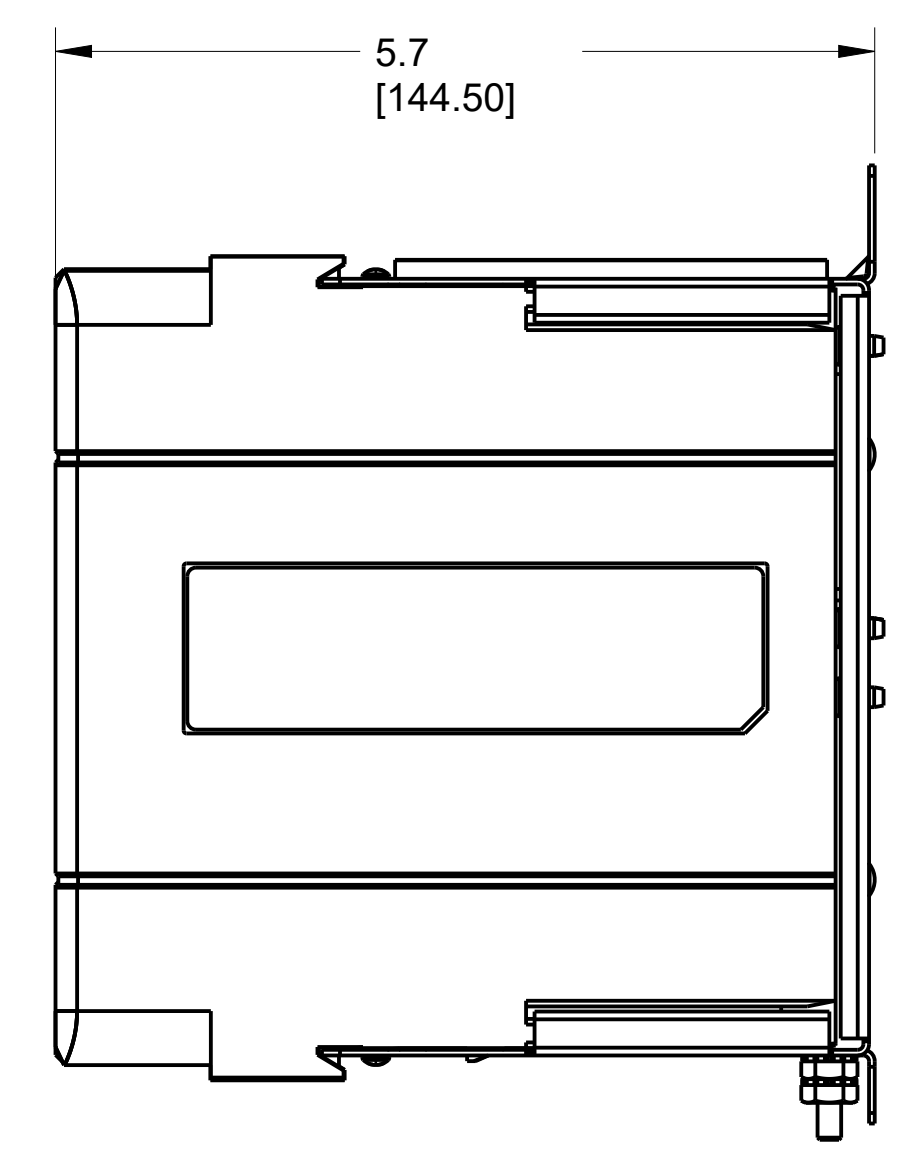
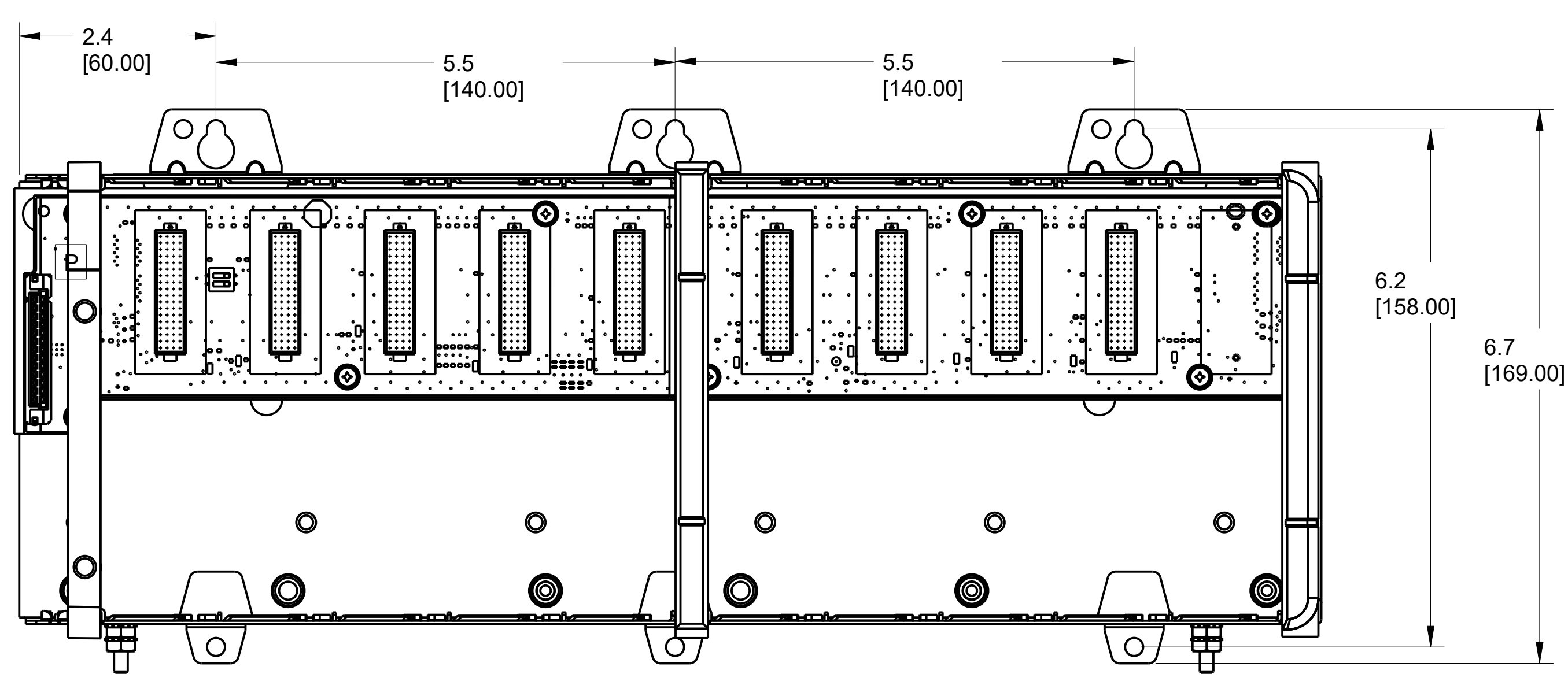
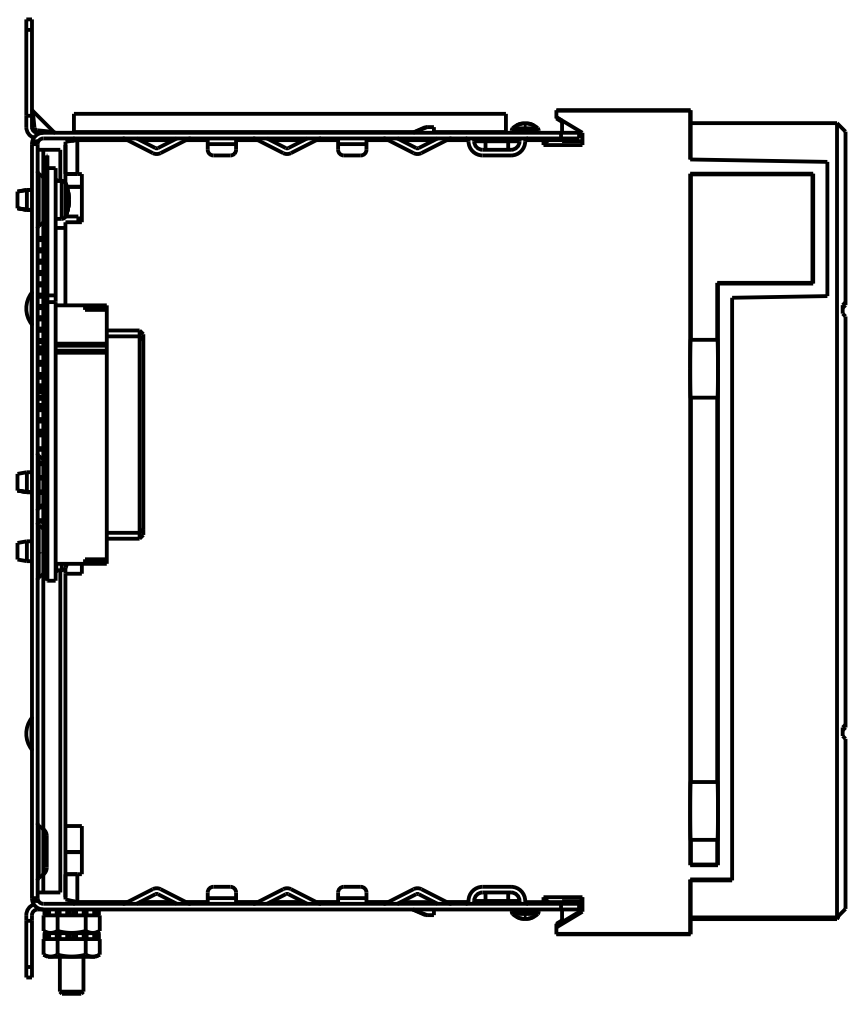
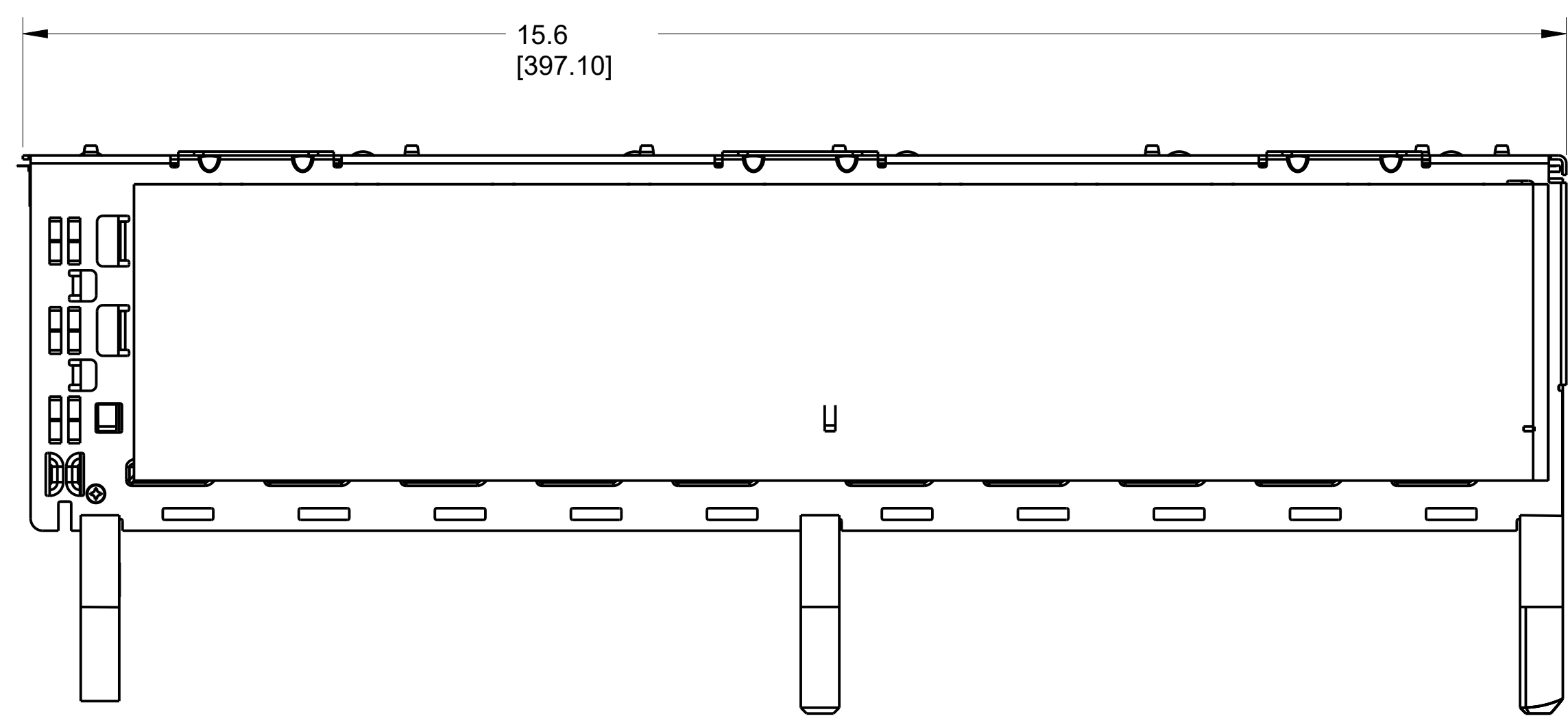

1 2 3 4 5 6 7 8

		<small>CONFIDENTIAL AND PROPRIETARY INFORMATION THIS DOCUMENT CONTAINS CONFIDENTIAL AND PROPRIETARY INFORMATION OF ROCKWELL AUTOMATION, INC. AND MAY NOT BE USED, COPIED OR DISCLOSED TO OTHERS, EXCEPT WITH THE AUTHORIZED WRITTEN PERMISSION OF ROCKWELL AUTOMATION, INC.</small>	
		DATE: 2018-08-23	SHEET 2 OF 2
<small>DESCRIPTION</small> CAT 1756-A10 C CUSTOMER DRAWING	<small>SIZE</small> D	<small>DIR</small> 10004235494	<small>VER</small> 01
	<small>CREATED BY: WBF</small>		<small>CHANGED BY: *****</small>