

# Bulletin 193

## E1 Plus EtherNet/IP Side Mount Module

Catalog Number 193-ETN

User Manual



**Allen-Bradley**



## Important User Information

Solid state equipment has operational characteristics differing from those of electromechanical equipment. *Safety Guidelines for the Application, Installation and Maintenance of Solid State Controls* (Publication SGI-1.1 available from your local Rockwell Automation sales office or online at <http://www.ab.com/manuals/gi>) describes some important differences between solid state equipment and hard-wired electromechanical devices. Because of this difference, and also because of the wide variety of uses for solid state equipment, all persons responsible for applying this equipment must satisfy themselves that each intended application of this equipment is acceptable.

In no event will Rockwell Automation, Inc. be responsible or liable for indirect or consequential damages resulting from the use or application of this equipment.

The examples and diagrams in this manual are included solely for illustrative purposes. Because of the many variables and requirements associated with any particular installation, Rockwell Automation, Inc. cannot assume responsibility or liability for actual use based on the examples and diagrams.

No patent liability is assumed by Rockwell Automation, Inc. with respect to use of information, circuits, equipment, or software described in this manual.

Reproduction of the contents of this manual, in whole or in part, without written permission of Rockwell Automation, Inc. is prohibited.

Throughout this manual, when necessary we use notes to make you aware of safety considerations.

---

**WARNING**

Identifies information about practices or circumstances that can cause an explosion in a hazardous environment, which may lead to personal injury or death, property damage, or economic loss.

---

---

**IMPORTANT**

Identifies information that is critical for successful application and understanding of the product.

---

---

**ATTENTION**

Identifies information about practices or circumstances that can lead to personal injury or death, property damage, or economic loss. Attentions help you:

- identify a hazard
  - avoid a hazard
  - recognize the consequence
- 

---

**SHOCK HAZARD**

Labels may be located on or inside the equipment (e.g., drive or motor) to alert people that dangerous voltage may be present.

---

---

**BURN HAZARD**

Labels may be located on or inside the equipment (e.g., drive or motor) to alert people that surfaces may be dangerous temperatures.

---

<b>Chapter 1 — Installation and Wiring</b>	Introduction . . . . .	1-1
	Features. . . . .	1-3
	Installation . . . . .	1-4
	Wiring. . . . .	1-5
	Dimensions. . . . .	1-6
	Network Design . . . . .	1-7
<b>Chapter 2 — Protection Functions</b>	Introduction . . . . .	2-1
	Trip Status / Identification . . . . .	2-1
	Trip Resetting. . . . .	2-1
	Trip and Warning Enable . . . . .	2-1
	Overload and Phase Loss Protection . . . . .	2-2
	Jam Protection . . . . .	2-3
	Underload Protection. . . . .	2-4
	Communication Fault Protection . . . . .	2-5
	Communication Idle Protection . . . . .	2-6
<b>Chapter 3 — Configure an E1 Plus EtherNet/IP Module To Operate on the Network</b>	Introduction . . . . .	3-1
	Determining Network Parameters . . . . .	3-1
	Setting the IP Network Address . . . . .	3-2
	Assign Network Parameters via the BOOTP/DHCP Utility . . . . .	3-2
	Assign Network Parameters Via a Web Browser and MAC Scanner Software . . . . .	3-4
	Other Factors to Consider When Assigning Network Parameters . . . . .	3-7
	Duplicate IP Address Detection . . . . .	3-7
	DNS Addressing . . . . .	3-8
	Install EDS File . . . . .	3-9
	Download EDS File Embedded in the Module. . . . .	3-9
	Download EDS File from Allen-Bradley EDS File Download Site . . . . .	3-10
	Register the EDS File . . . . .	3-11
	<b>Chapter 4 — Automation Controller and Software Communications</b>	Introduction . . . . .
I/O Messaging . . . . .		4-1
ControlLogix Configuration . . . . .		4-1
EtherNet/IP Network Configuration . . . . .		4-3
Downloading the Configuration to the PLC . . . . .		4-6
Accessing Module Data. . . . .		4-7
Logix Explicit Messaging. . . . .		4-8
MicroLogix and SLC-5/05 Explicit Messaging . . . . .		4-11
FactoryTalk View with Predefined Tags. . . . .	4-15	
<b>Chapter 5 — Email Notifications</b>	Introduction . . . . .	5-1
	Notification Events . . . . .	5-1
	Email Contents. . . . .	5-1
	Email Configuration. . . . .	5-2
	Configure Device Identity . . . . .	5-4
	Limitations . . . . .	5-6

## Chapter 6 — Device Parameters and Tags

Introduction . . . . .	6-1
Parameter and Tag Programming . . . . .	6-1
Program Lock . . . . .	6-1
Resetting to the Factory Default Values . . . . .	6-1
Parameter Group Listing . . . . .	6-2
Monitor Group . . . . .	6-2
Advanced Setup Group . . . . .	6-4
Reset/Lock Group . . . . .	6-7
I/O Setup Group . . . . .	6-8
Trip History Group . . . . .	6-10

## Chapter 7 — Troubleshooting

Introduction . . . . .	7-1
EtherNet/IP Modes of Operation . . . . .	7-2
Power-Up Reset Mode . . . . .	7-2
Run Mode . . . . .	7-2
Recoverable Error Mode . . . . .	7-3
Unrecoverable Error Mode . . . . .	7-3
EtherNet/IP Troubleshooting Procedures . . . . .	7-4
Input and Output Troubleshooting Procedures . . . . .	7-5

## Appendix A — Specifications

. . . . .	A-1
-----------	-----

## Appendix B — EtherNet/IP Information

Electronic Data Sheets . . . . .	B-1
EtherNet/IP Objects . . . . .	B-1
Identity Object — CLASS CODE 0x01 . . . . .	B-2
Message Router Object — CLASS CODE 0x02 . . . . .	B-3
Assembly Object — CLASS CODE 0x04 . . . . .	B-3
Connection Manager Object — CLASS CODE 0x06 . . . . .	B-5
Discrete Input Point Object — CLASS CODE 0x08 . . . . .	B-6
Discrete Output Point Object — CLASS CODE 0x09 . . . . .	B-7
Parameter Object — CLASS CODE 0x0F . . . . .	B-8
Parameter Group Object — CLASS CODE 0x10 . . . . .	B-9
Control Supervisor Object — CLASS CODE 0x29 . . . . .	B-10
Overload Object — CLASS CODE 0x2C . . . . .	B-12
PCP Object — CLASS CODE 0xC2 . . . . .	B-13
TCP/IP Interface Object — CLASS CODE 0xF5 . . . . .	B-14
Ethernet Link Object — CLASS CODE 0xF6 . . . . .	B-15
Rockwell Automation Support . . . . .	B-17
Installation Assistance . . . . .	B-17
New Product Satisfaction Return . . . . .	B-17



---

## Installation and Wiring

### Introduction

The purpose of this chapter is to provide the necessary instructions to successfully install an E1 Plus EtherNet/IP Module to an E1 Plus Overload Relay and properly connect to a EtherNet/IP network.

---

**ATTENTION**

To prevent electrical shock, disconnect from power source before installing or servicing. Install in suitable enclosure. Keep free from contaminants.

---

**ATTENTION**

The side mount module contains ESD (electrostatic discharge) sensitive parts and assemblies. Static control precautions are required when installing, testing, servicing, or repairing this assembly. Component damage may result if ESD control procedures are not followed. If you are not familiar with static control procedures, refer to Rockwell Automation publication 8000-4.5.2, “*Guarding Against Electrostatic Damage*”, or any other applicable ESD protection handbook.

---

**ATTENTION**

The purpose of this document is to serve as a guide for proper installation. The National Electrical Code and any other governing regional or local code will take precedence. Rockwell Automation cannot assume responsibility for the compliance or proper installation of the side mount module or associated equipment. A hazard of personal injury and/or equipment damage exists if codes are ignored during installation.

---

**ATTENTION**

An incorrectly applied or installed side mount module can result in damage to the components or reduction in product life. Wiring or application errors such as supplying incorrect or inadequate supply voltage, or operating/storing in excessive ambient temperatures may result in malfunction of the product.

---

**ATTENTION**



Only personnel familiar with the side mount module and associated machinery should plan to install, set up, and maintain the system. Failure to comply may result in personal injury and/or equipment damage.

**ATTENTION**



This is a Class A product. In a domestic environment, this product may cause radio interference, in which case, the user may be required to take adequate measures.

**ATTENTION**



To remain compliant with UL/CSA Certifications, the EtherNet/IP power supply must meet NEC Class 2 requirements.

# Features

Figure 1.1 Features

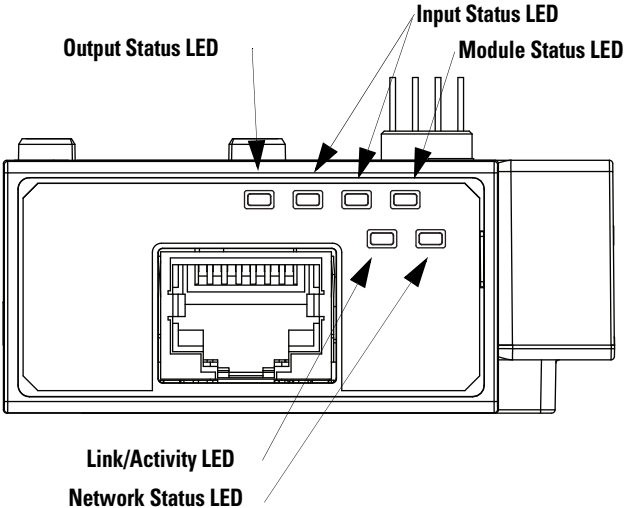
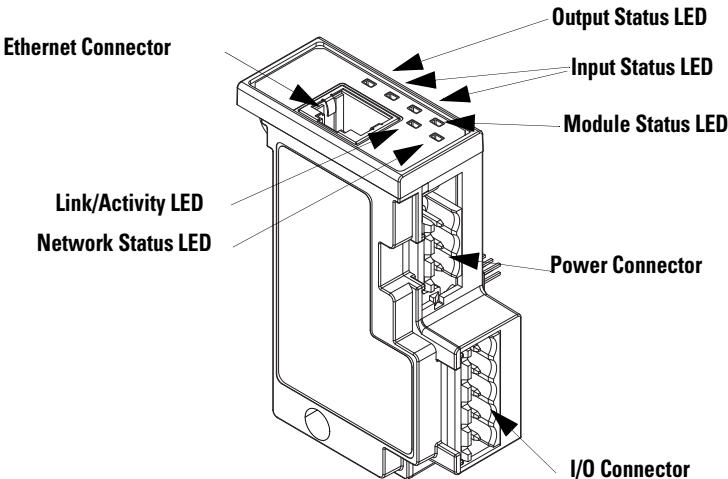

# Installation

Figure 1.2 Installation [1]

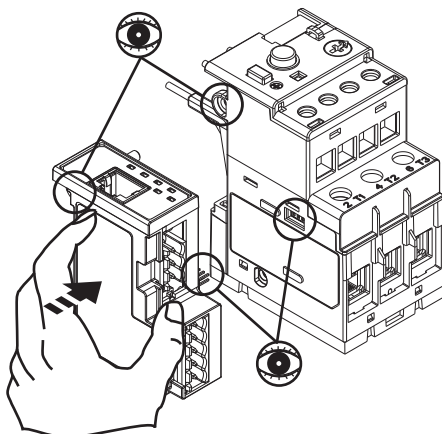

Figure 1.3 Installation [2]

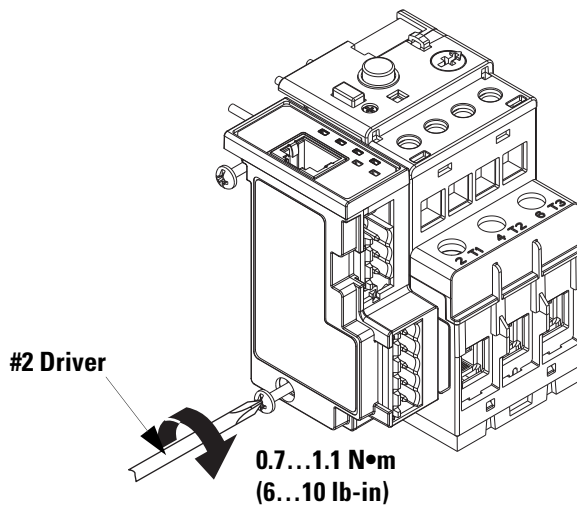
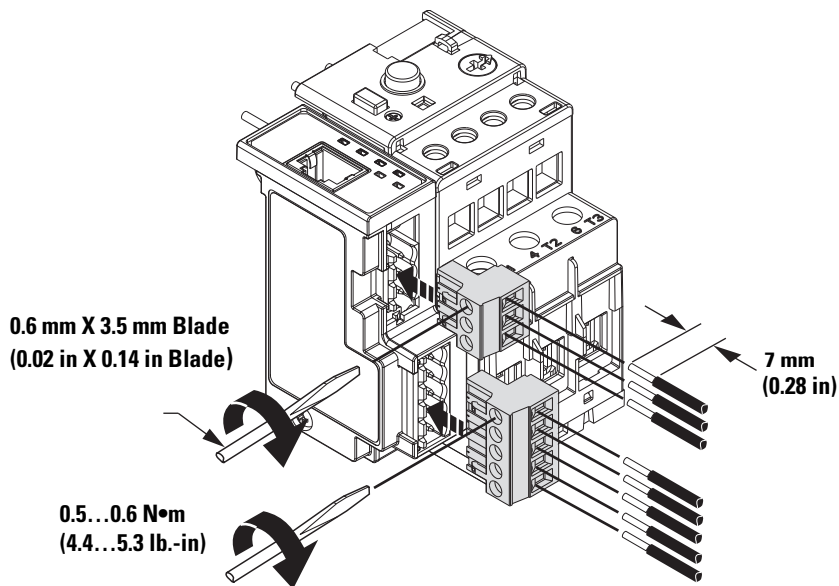
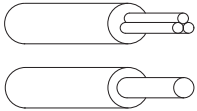
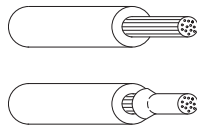
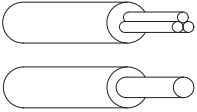

Figure 1.4 Installation [3]



# Wiring

**Table 1.1 Wire and Size Torque Specifications**

	<p>1X</p> <p>2X</p>	<p>24...12 AWG</p> <p>24...16 AWG</p> <p>5 lb.-in</p>
	<p>1X</p> <p>2X</p>	<p>0.2...2.5 mm<sup>2</sup></p> <p>0.25...1 mm<sup>2</sup></p> <p>0.56 N•m</p>
	<p>1X</p> <p>2X</p>	<p>0.2...2.5 mm<sup>2</sup></p> <p>0.2...1 mm<sup>2</sup></p> <p>0.56 N•m</p>

**Figure 1.5 Wiring Diagram**

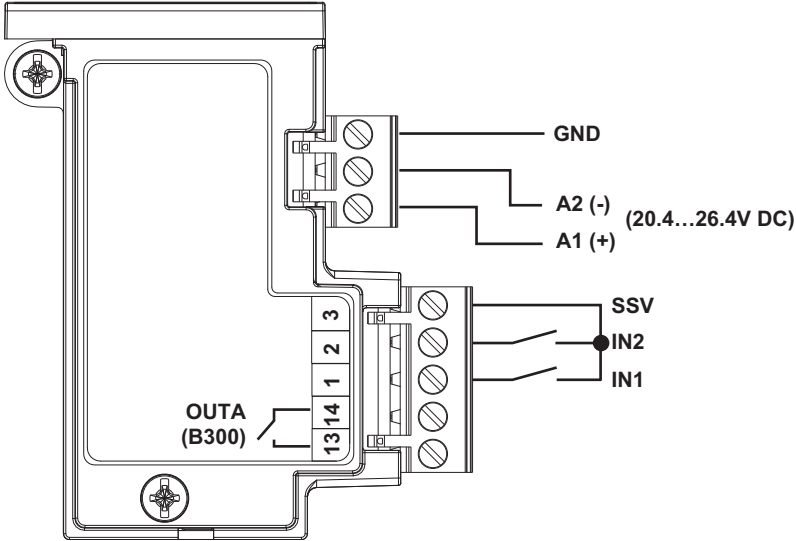

## Dimensions

Figure 1.6 Dimension Diagram

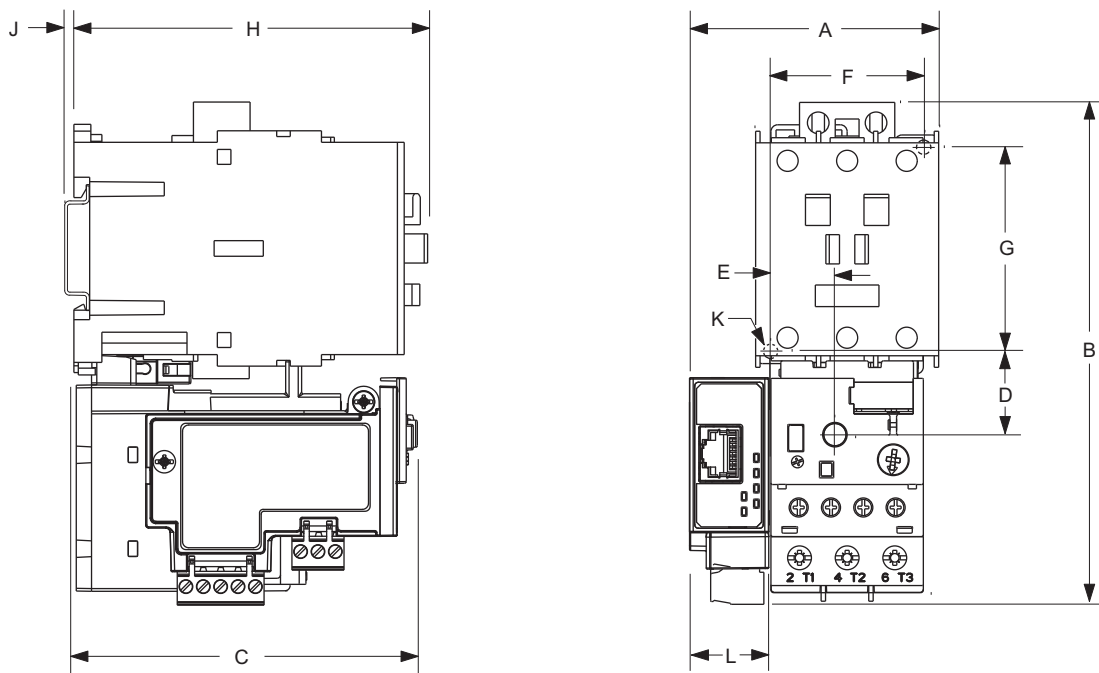

Table 1.2 Dimension Specifications

Contactor Cat. No.	E1 Plus Cat. No.	A	B	C	D	E	F	G	H	J	K	L
100-C09, -C12, -C16, -C23	193*-EE_B	67,3 mm (2.65 in)	148 mm (4.83 in)	85.2 mm (3.35 in)	24.5 mm (0.96 in)	13.9 mm (0.55 in)	35 mm (1.38 in)	60 mm (2.36 in)	86.5 mm (3.40 in)	2 mm (0.08 in)	4.5 mm (0.17 in)	22,3 mm (0.88 in)
100-C30, -C37	193*EE_D	67,3 mm (2.65 in)	148 mm (5.83 in)	101.2 mm (3.98 in)	24.5 mm (0.96 in)	13.9 mm (0.56 in)	35 mm (0.55 in)	60 mm (2.36 in)	104 mm (4.09 in)	2 mm (0.08 in)	4.5 mm (0.17 in)	22,3 mm (0.88 in)
100-C43		71.8 mm (2.83 in)	148 mm (5.83 in)	101.2 mm (3.98 in)	24.5 mm (0.96 in)	18.4 mm (0.74 in)	45 mm (1.77 in)	60 mm (2.36 in)	104 mm (4.09 in)	2 mm (0.08 in)	4.5 mm (0.17 in)	22,3 mm (0.88 in)
100-C60, -C72, -C85	193*-EE_E	94,3 mm (3.71 in)	191.6 mm (7.54 in)	120.4 mm (4.74 in)	29 mm (1.14 in)	23.8 mm (0.94 in)	55 mm (2.16 in)	100 mm (3.94 in)	126 mm (4.94 in)	2 mm (0.08 in)	5.4 mm (0.21 in)	22,3 mm (0.88 in)

## Network Design

The E1 Plus EtherNet/IP module has one RJ45 port to connect a CAT5 type or better Ethernet cable. Allen-Bradley offers a wide variety of Ethernet patch cables with its Bulletin 1585 line of Ethernet cables (<http://www.ab.com/sensors/ethernet/incabinet.html>).

The E1 Plus supports a Star Ethernet topology in which all Ethernet nodes wire back to a central Ethernet switch, hub, or router as shown below:

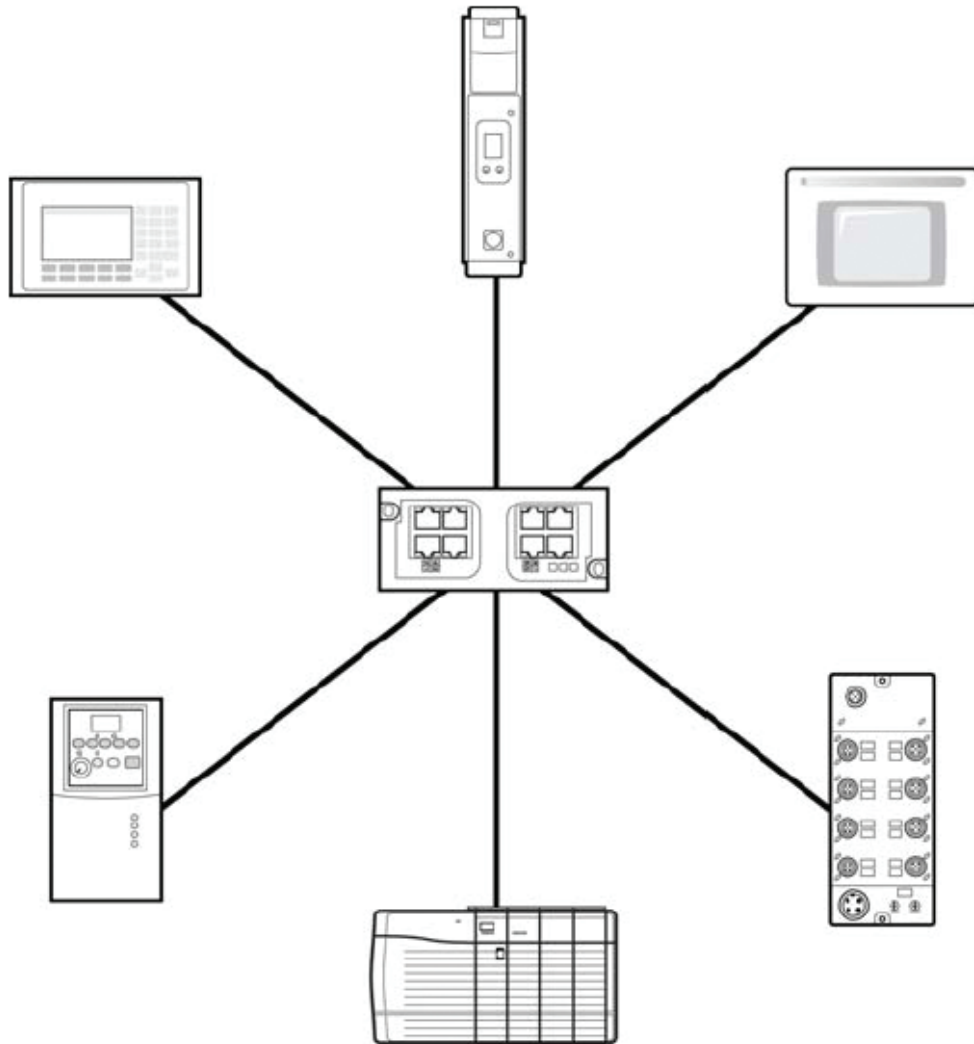

Allen-Bradley offers a line of managed and unmanaged Ethernet Switches with its Stratix family of Ethernet Switches (<http://www.ab.com/networks/switches/>).





## Protection Functions

### Introduction

The purpose of this chapter is to provide detailed information regarding the protective trip and warning functions that the E1 Plus EtherNet/IP Module adds to the E1 Plus Overload Relay. In this chapter, you will find considerable mention given to parameters as they relate to these functions. For complete descriptions of the programming parameters, refer to *Chapter 6- Device Parameters and Tags*.

### Trip Status / Identification

The E1 Plus EtherNet/IP Module determines trip status and identification through monitoring of reference signals inside the E1 Plus Overload Relay. On power-up, it assumes that the E1 Plus Overload Relay is in a non-tripped condition. For definitive feedback on trip status of the E1 Plus Overload Relay, one of the E1 Plus EtherNet/IP module inputs may be wired to the N.O. auxiliary contact (terminals 97 and 98) of the E1 Plus Overload Relay. Parameters 40 and 41 are used to configure the assignment of the inputs. For this function, use the “OL Contact” configuration.

### Trip Resetting

The following options are available for resetting a tripped E1 Plus Overload Relay with an E1 Plus EtherNet/IP module:

- Blue mechanical reset button located on the front of the E1 Plus Overload Relay
- Setting Parameter 14, *Trip Reset*, to “Reset trip”
- Setting the trip reset bit in an output assembly from a logic controller
- Using a push button (N.O. contact configuration) wired to one of the EtherNet/IP module inputs, programming the corresponding input assignment parameter (40 or 41) to “Trip Reset”
- Setting the CIP Tag, *Trip\_Reset*, to 1

---

**IMPORTANT**

Setting parameter 16, *Reset Mode*, to “Automatic” does not result in other reset commands being ignored.

---

### Trip and Warning Enable

Parameter 12, *Trip Enable*, allows the installer to enable or disable the jam trip protective function.

Parameter 13, *Warning Enable*, allows the installer to enable or disable the overload, jam, underload, and communication warning protective functions.

**ATTENTION**

The Trip Enable settings should not be altered during machine operation, as unexpected behavior could occur. This may result in an unintended actuation of controlled industrial equipment, with the potential for machine damage or serious injury to personnel.

## Overload and Phase Loss Protection

Thermal overload and phase loss trip protection is provided exclusively by the E1 Plus Overload Relay. The E1 Plus Overload Relay provides uninterrupted protection to the motor, even in the event of an E1 Plus EtherNet/IP Module failure. Settings for FLA and trip class are found directly on the E1 Plus Overload Relay.

**IMPORTANT**

The reset mode DIP switch adjustment is overridden by the E1 Plus EtherNet/IP module parameter 16, *OL Reset Mode*, while the E1 Plus EtherNet/IP module is powered.

## Overload Warning

The E1 Plus EtherNet/IP Module continuously monitors the E1 Plus Overload Relay's percentage of thermal utilization signal. Parameter 2, *%Therm Utilized*, provides this value.

Parameter 17, *OL Warn Level*, is used to adjust the setpoint to alert for an impending overload trip and is adjustable from 0...100% TCU.

The E1 Plus EtherNet/IP Module will indicate an overload warning if all the following conditions are met:

- No warning currently exists
- Overload warning is enabled
- *%Therm Utilized* is equal to or greater than *OL Warn Level*

When the overload warning conditions are satisfied, the following will occur:

- Bit 0 in Parameter 4, *Warning Status*, will go to “1”
- Bit 1 of Parameter 10, *Device Status*, will go to “1”

**IMPORTANT**

*%Therm Utilized* will stabilize at a value of approximately 88% with the motor operating continuously at rated current.

## Jam Protection

Motor current greater than the motor's nameplate rating can indicate a high overload or stall condition, such as an overloaded conveyor or jammed gear. These conditions can result in overheating of the motor, and equipment damage. Rapid jam fault detection helps to minimize damage and loss of production.

By continuously monitoring the motor current level signal as a percentage of the E1 Plus Overload Relay's dial FLA setting, the E1 Plus EtherNet/IP module allows jam trip and warning capability.

### Jam Trip

The following parameters are available for configuring the E1 Plus EtherNet/IP Module's jam trip performance:

- Parameter 18, *Jam Inhibit Time*, allows the installer to inhibit a jam trip from occurring during the motor starting sequence. It is adjustable from 0...250 seconds.
- Parameter 19, *Jam Trip Delay*, allows the installer to define the time period a jam condition must be present before a trip occurs. It is adjustable from 5...250 seconds.
- Parameter 20, *Jam Trip Level*, allows the installer to define the current at which the E1 Plus Overload Relay will trip on a jam. It is user-adjustable from 150...600% of the FLA dial setting.

The E1 Plus EtherNet/IP Module will command the E1 Plus Overload Relay to trip if all the following conditions are met:

- No trip currently exists
- *Jam Protection* is enabled
- *Jam Inhibit Time* has expired
- The motor current is greater than the *Jam Trip Level* for a time period greater than the *Jam Trip Delay*

When the conditions for a jam trip are satisfied, the following will occur:

- Bit 2 in Parameter 3, *Trip Status*, will go to “1”
- Bit 0 in Parameter 10, *Device Status*, will go to “1”
- The E1 Plus Overload Relay's trip relay contacts (95 and 96) will open
- Out A will be placed in their Protection Fault State (if so programmed)

---

**IMPORTANT**

The Protection Fault State of OUT A is defined by parameter 34 (*OUTA Pr FltState*) and parameter 35 (*OUTA Pr FltValue*).

---

---

**IMPORTANT**

The jam inhibit timer starts after the load current transitions from 0 A to 30% FLA. The E1 Plus EtherNet/IP Module does not begin monitoring for a jam condition until the *Jam Inhibit Time* expires.

---

## Jam Warning

Parameter 21, *Jam Warn Level*, allows the installer to define the current at which the EtherNet Module will indicate a warning. It is user-adjustable from 100...600% FLA.

The E1 Plus EtherNet/IP Module will indicate a Jam warning if:

- No warning currently exists
- Jam Warning is enabled
- Jam Inhibit Time has expired
- The motor current is equal to or greater than the Jam Warn Level

When the Jam Warning conditions are satisfied, the following will occur:

- Bit 2 in Parameter 4, Warning Status, will go to “1”
- Bit 1 in Parameter 10, Device Status, will go to “1”

---

**IMPORTANT**

The Jam Warning function does not include a time delay feature. Once the *Jam Inhibit Time* has expired, the Jam Warning indication is instantaneous.

---

## Underload Protection

Motor current less than a specific level may indicate a mechanical malfunction in the installation, such as a torn conveyor belt, damaged fan blade, broken shaft, or worn tool. Such conditions may not harm the motor, however, rapid detection may help to minimize equipment damage and loss of production.

## Underload Warning

The following parameters are available for configuring the E1 Plus EtherNet/IP Module's underload warning performance:

- Parameter 22, *UL Inhibit Time*, allows the installer to inhibit an underload indication from occurring during the motor starting sequence. It is adjustable from 0...250 seconds.
- Parameter 23, *UL Warn Level*, allows the installer to define the current at which the E1 Plus EtherNet/IP Module will indicate a warning. It is user-adjustable from 30...100% of the FLA dial setting.

The E1 Plus EtherNet/IP Module will immediately indicate an Underload warning if:

- No warning currently exists
- *Underload Warning* is enabled
- *UL Inhibit Time* has expired
- The motor current is less than the *UL Warn Level*

When the Underload Warning conditions are satisfied, the following will occur:

- Bit 3 in Parameter 4, *Warning Status*, will go to “1”
- Bit 1 of Parameter 10, *Device Status*, will go to “1”

---

**IMPORTANT**

The Underload Warning function does not include a time delay feature. Once the *UL Inhibit Time* has expired, the Underload warning indication is instantaneous.

---

## Communication Fault Protection

A disruption of the communication link between the E1 Plus EtherNet/IP Module and a EtherNet/IP network can result in the loss of application control and/or critical process diagnostic data. Rapid communication fault detection helps minimize potential damage due to uncontrolled or unmonitored applications.

### Comm Fault Warning

The E1 Plus EtherNet/IP Module will indicate a Comm Fault warning if:

- No warning currently exists
- Comm Fault Warning is enabled
- The EtherNet/IP Module experiences a loss of communication

When the Comm Fault warning conditions are satisfied, the following will occur:

- The Network Status LED will blink red or become solid red

- Bit 5 in Parameter 4, *Warning Status*, will go to “1”
- Bit 1 of Parameter 10, *Device Status*, will go to “1”

---

**IMPORTANT**

The Comm Fault State of OUT A is defined by Parameter 36 (*OUTA En FltState*) and parameter 37 (*OUTA En FltValue*).

---

## Communication Idle Protection

When a programmable controller is placed into the program mode, the execution of its ladder program is suspended, and any connected networks go to an idle state. If inadvertent, this can result in the loss of application control and/or critical process diagnostic data. Rapid communication idle detection helps minimize the potential damage due to uncontrolled or unmonitored applications.

### Comm Idle Warning

The E1 Plus EtherNet/IP Module will indicate a Comm Idle warning if:

- No warning currently exists
- Comm Idle Warning is enabled
- The network controller that is communicating to the E1 Plus EtherNet/IP Module is placed in idle mode

When the Comm Idle warning conditions are satisfied, the following will occur:

- Bit 6 in Parameter 4, *Warning Status*, will go to “1”
- Bit 1 in Parameter 10, *Device Status*, will go to “1”

---

**IMPORTANT**

The Comm Idle State of OUT A is defined by Parameter 38 (*OUTA En IdlState*) and parameter 39 (*OUTA En IdlValue*).

---

# Configure an E1 Plus EtherNet/IP Module To Operate on the Network

## Introduction

This chapter describes how to configure an E1 Plus EtherNet/IP module to operate on an EtherNet/IP network.

When you first install an E1 Plus EtherNet/IP module, the module is Dynamic Host Configuration Protocol (DHCP) enabled.

## Determining Network Parameters

To operate an EtherNet/IP network, you must define these parameters.

### EtherNet/IP Network Parameters

EtherNet/IP Network Parameter	Description
IP address	<p>The IP address uniquely identifies the module. The IP address is in the form xxx.xxx.xxx.xxx where each xxx is a number from 0...255. These are reserved values you cannot use:</p> <ul style="list-style-type: none"> <li>• 0.0.0.1...0.255.255.255</li> <li>• 127.0.0.0...127.255.255.255</li> <li>• 224.255.255.255...255.255.255.255</li> </ul>
Subnet mask	<p>Subnet addressing is an extension of the IP address scheme that allows a site to use a single network ID for multiple physical networks. Routing outside of the site continues by dividing the IP address into a net ID and a host ID via the class. Inside a site, the subnet mask is used to redivide the IP address into a custom network ID portion and host ID portion.</p> <p>If you change the subnet mask of an already-configured module, you must cycle power to the module for the change to take effect.</p>
Gateway	<p>A gateway connects individual physical networks into a system of networks. When a node needs to communicate with a node on another network, a gateway transfers the data between the two networks.</p>

If you use DNS addressing, or reference the module via a host name in an MSG instruction, then define these parameters.

### EtherNet/IP Network Parameters for DNS Addressing

EtherNet/IP Network Parameter	Description
Host name	A host name is part of a text address that identifies the module. The full text address of a module is <i>host_name.domain_name</i> .
Domain name	A domain name is part of a text address that identifies the domain in which the module resides. The full text address of a module is <i>host_name.domain_name</i> . The domain name has a 48-character limit.
Primary DNS server address	This identifies any DNS servers used in the network. You must have a DNS server configured if you specify an SMTP server with a name. The DNS server converts the domain name or host name to an IP address that can be used by the network.
Secondary DNS server address	
For more information on DNS addressing, see page 3-8.	

Check with your Ethernet network administrator to determine if you need to specify these parameters.

## Setting the IP Network Address

E1 Plus EtherNet/IP modules ship with DHCP enabled. You can set the network Internet Protocol (IP) address by:

- Using a Bootstrap Protocol (BOOTP)/Dynamic Host Configuration Protocol (DHCP) server, such as the Rockwell Automation BOOTP-DHCP Server Utility, which is included with Rockwell Software's RSLinx™ Classic software
- Using a web browser and MAC Scanner software

## Assign Network Parameters via the BOOTP/DHCP Utility

By default, the E1 Plus EtherNet/IP module is DHCP enabled. The BOOTP/DHCP utility is a standalone program that is located in the:

- BOOTP-DHCP Server folder accessed from the Start menu.

### IMPORTANT

Before you start the BOOTP/DHCP utility, make sure you have the hardware MAC ID of the module, which is printed on the side of the E1 Plus EtherNet/IP module. The MAC ID has a format similar to: 00-0b-db-14-55-35.

This utility recognizes DHCP-enabled devices and provides an interface to configure a static IP address for each device.



To assign network parameters via the BOOTP/DHCP utility, perform this procedure.

1. Start the BOOTP/DHCP software.
2. Select Tool → Network Settings.
3. If appropriate for the network, enter the subnet mask, gateway address, primary/secondary server addresses, and domain name.

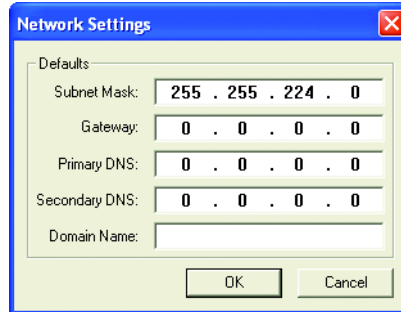

4. Click OK.

The Request History panel displays the hardware addresses of modules issuing BOOTP or DHCP requests.

5. Double-click the MAC address of the module to be configured.

The MAC address is printed on the side of the E1 Plus EtherNet/IP module. The format of the hardware address resembles 00-0b-db-14-55-35.

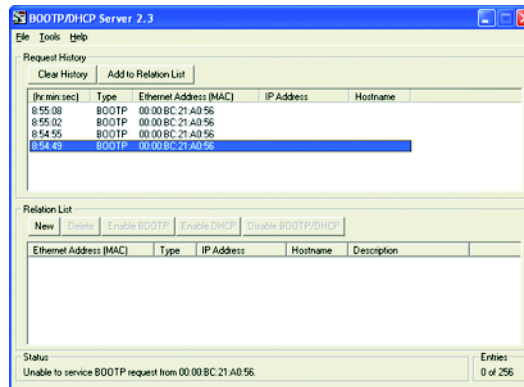

The New Entry window appears with the module's Ethernet Address (MAC).

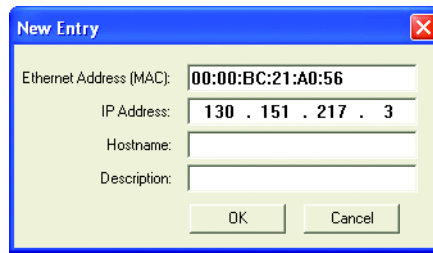

6. Enter the IP address, host name, and a module description.
7. Click OK.
8. RE-cycle power to the module.
9. To permanently assign this configuration to the module, highlight the module in the Relation List panel and click the Disable BOOTP/DHCP button.

When module power is recycled, it uses the assigned configuration and does not issue a DHCP request.

If you do not select the Disable BOOTP/DHCP button, on a power cycle, the module clears the current IP configuration and will again begin sending DHCP requests.

## Assign Network Parameters Via a Web Browser and MAC Scanner Software

In the event that a user does not have access to a DHCP software utility, a user can assign network parameters via a web browser, such as Microsoft's Internet Explorer, and Media Access Control (MAC) scanner software, such as MAC Scanner from Colasoft - <http://www.colasoft.com/>. Follow these steps to configure the module using this method.

1. Locate and identify the MAC ID printed on the label of the E1 Plus EtherNet/IP Side Mount Module. This address has a format that is similar to: 00-0b-db-14-55-35
2. Connect the E1 Plus EtherNet/IP Side Mount Module to the same Wide Area Network (WAN) as your personal computer.
3. Start the MAC scanner software
4. Select the appropriate subnet to scan for available MAC addresses.

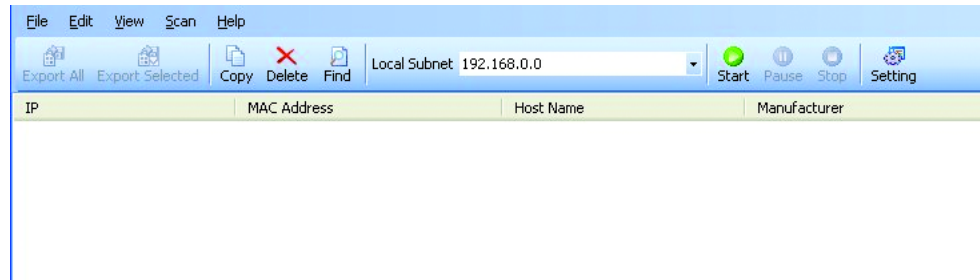

5. Scan the Subnet for all available MAC addresses.

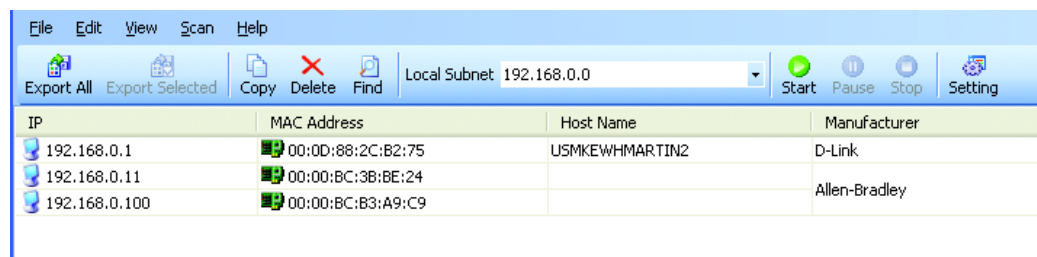

6. Identify the IP address assigned to the MAC ID of the E1 Plus EtherNet/IP Side Mount Module. The IP address will have a format that is similar to 192.168.0.100.

7. Open a web browser and type the IP address on the address line to view the internal web server of the E1 Plus EtherNet/IP Side Mount Module.

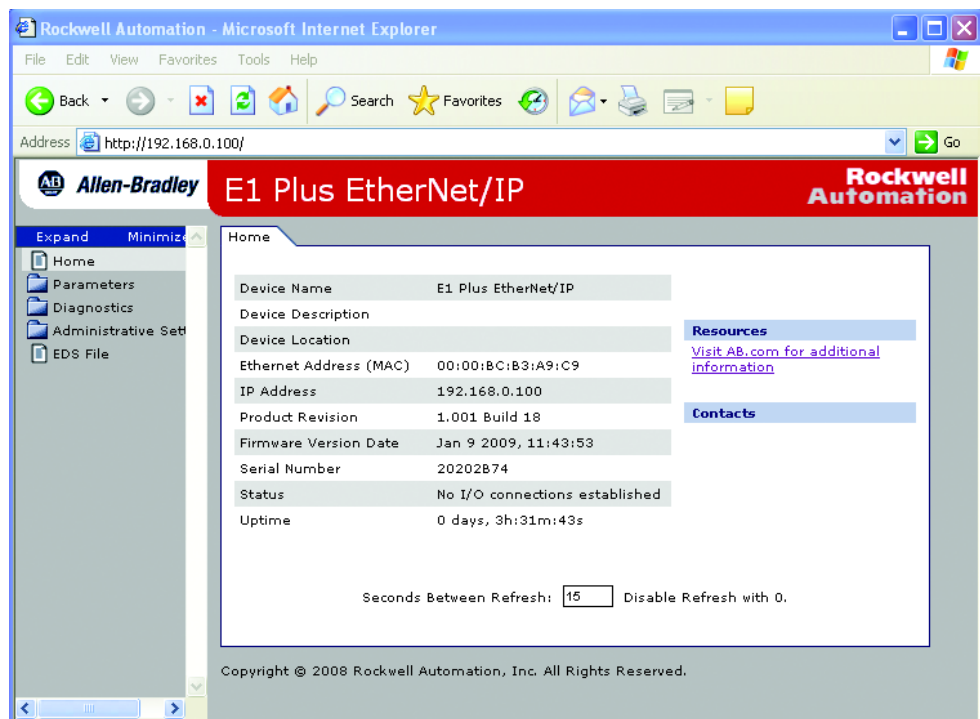

8. Select **Administration Settings->Network Configuration** to change the IP address of the E1 Plus EtherNet/IP Side Mount Module to a static IP address.
9. The module will prompt the user for a User Name and Password. Use “Administrator” for the user name, leave the password field blank, and select OK.

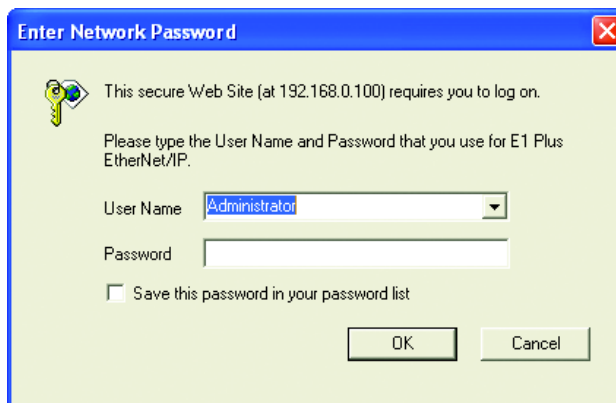

10. Assign the appropriate network settings per the recommendation of the network administrator for the network that this module will be communicating on and select **Apply**.

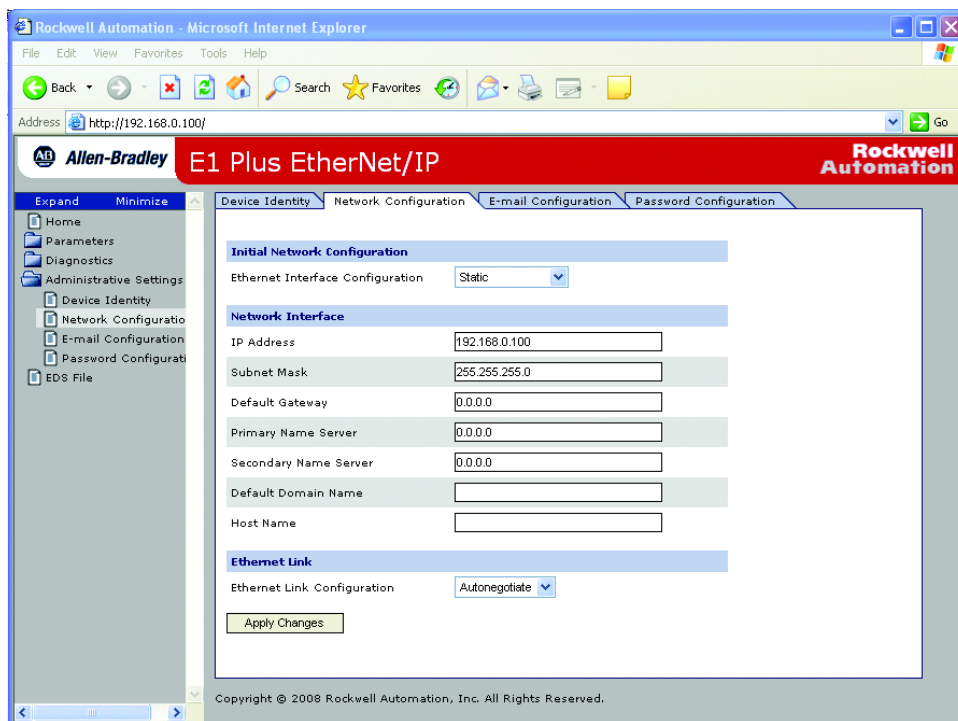

11. Recycle the power on the E1 Plus EtherNet/IP module for the communications changes to take affect.

## Other Factors to Consider When Assigning Network Parameters

There are other factors to consider when assigning networks parameters, which include:

- Network isolation from or integration into the plant/enterprise network
- Network size

For large networks, even isolated networks, it might be more convenient and safer to use a BOOTP/DHCP server rather than RSLinx software. The BOOTP/DHCP server also limits the possibility of assigning duplicate IP addresses.

- Company policies and procedures dealing with plant floor network installation and maintenance
- Level of involvement by IT personnel in plant floor network installation and maintenance
- Type of training offered to control engineers and maintenance personnel

If you use the Rockwell Automation BOOTP or DHCP server in an uplinked subnet where an enterprise DHCP server exists, a module may get an address from the enterprise server before the Rockwell Automation utility even sees the module. You might have to disconnect from the uplink to set the address and configure the module to retain its static address before reconnecting to the uplink. This is not a problem if you have node names configured in the module and leave DHCP enabled.

### ATTENTION



The E1 Plus EtherNet/IP module must be assigned a fixed network address. The IP address of this module must not be dynamically provided.

Failure to observe this precaution may result in unintended machine motion or loss of process control.

## Duplicate IP Address Detection

When you change the IP address or connect the module to an EtherNet/IP network, the module checks to make sure that the IP address assigned to this module does not match the address of any other network device. If the module determines that another device on the network with a matching IP address, the EtherNet/IP port of the module goes into conflict mode.

- *NETWORK STATUS* LED indicator is solid red.

To resolve this conflict, use the instructions in this chapter to change the IP address of the module. Then cycle power to the module or reset the modules by disconnecting and then reconnecting the EtherNet cable cable.

Two modules could possibly detect a conflict simultaneously. If this occurs, perform this procedure.

1. Remove the module with the incorrect IP address and correct its conflict.
2. Cycle power or disconnect the EtherNet cable from the second module and reconnect it.

### Behavior of Modules With Duplicate IP Addresses

Devices in conflict over an IP address behave differently depending on whether connections have been established to either of the modules and whether both modules support duplicate IP address detection.

#### Device Conflict Over Duplicate IP Addresses

If	Then
Both modules support duplicate IP address detection	The first started module uses and retains its IP address. The other module will detect a conflict, give up the IP address and enter conflict mode.
Both modules support duplicate IP address detection and are started at roughly the same time	One of them surrenders the IP address and enters conflict mode.
One module supports duplicate IP address detection and a second module does not	The second module generally keeps its IP address, regardless of which module first obtains the IP address. The module that supports duplicate IP address detection will detect the conflict and give up the IP address.

### DNS Addressing

To further qualify a module’s address, use DNS addressing to specify a host name for a module, which also includes specifying a domain name and DNS servers. DNS addressing makes it possible to set up similar network structures and IP address sequences under different domains.

DNS addressing is only necessary if you refer to the module by host name, such as in path descriptions in MSG instructions.

To use DNS addressing, perform this procedure.

1. Assign a host name to the module.

A network administrator should be able to assign a host name. Valid host names should be IEC-1131-3 compliant.

2. Configure the module's parameters.

- In addition to the IP address, subnet mask, and gateway address, configure a host name for the module, domain name, and primary/secondary DNS server addresses.

## Install EDS File

Before the E1 Plus EtherNet/IP Side Mount Module is configured to communicate on an EtherNet/IP network, it must be registered to the software that configures the network such as Rockwell Software's RSLinx Classic and RSNetWorx for EtherNet/IP software. A user registers the module by installing an Electronic Data Sheet (EDS file). The EDS file for the E1 Plus EtherNet/IP Side Mount Module can be obtained from one of two locations:

- Embedded in the module
- Allen-Bradley EDS file download website

## Download EDS File Embedded in the Module

The EDS file for the E1 Plus EtherNet/IP Side Mount Module is embedded within the module. After the IP address for the module has been configured, connect the module to same Ethernet network as a personal computer. Using a web browser on the personal computer, a user can download the EDS file using a web browser by following these steps:

- Type the IP address of the E1 Plus EtherNet/IP Side Mount Module on the address line of the web browser.

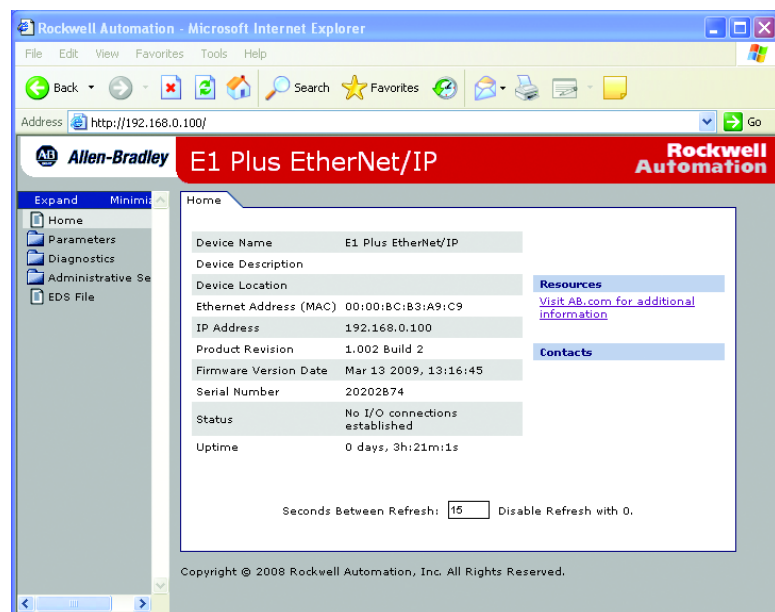

2. Right click on the EDS File link
3. Select Save to save the EDS file to the personal computer.

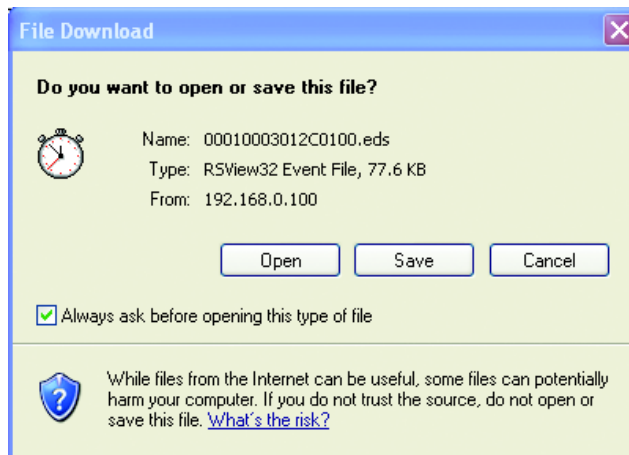

## Download EDS File from Allen-Bradley EDS File Download Site

The EDS file for the E1 Plus EtherNet/IP Side Mount Module can also be downloaded from the Allen-Bradley EDS File download site. Using a web browser on the personal computer that is connected to the Internet, a user can download the EDS file by following these steps:

1. Type <http://www.ab.com/networks/eds> on the address line of the web browser.
2. Select the network type as EtherNet/IP and select Search.

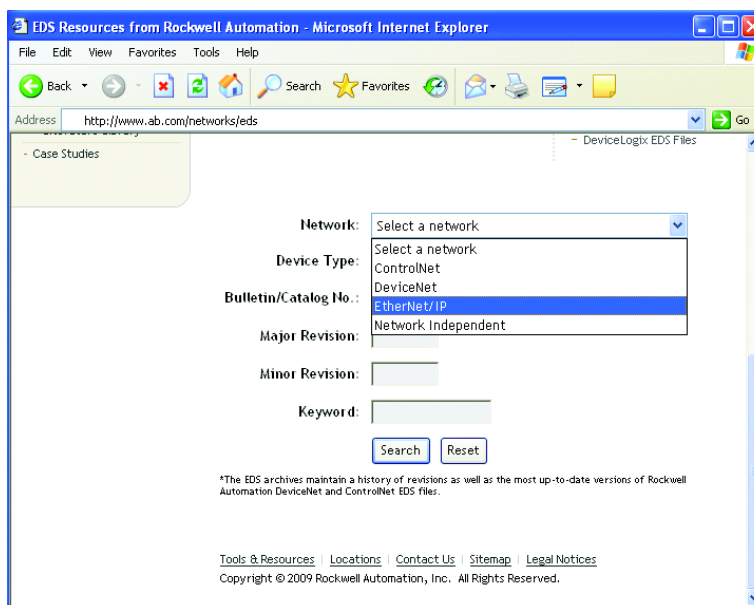



3. Locate the EDS file for the E1 Plus EtherNet/IP Side Mount Module and download it to the personal computer.

## Register the EDS File

After the EDS file has been downloaded, a user will need to register the EDS file with the software that configures the EtherNet/IP network. The following example lists the steps needed to register an EDS file with Rockwell Software's RSLinx Classic software.

1. Start the EDS Hardware Installation Tool, located at Start->Programs->Rockwell Software->RSLinx Tools.

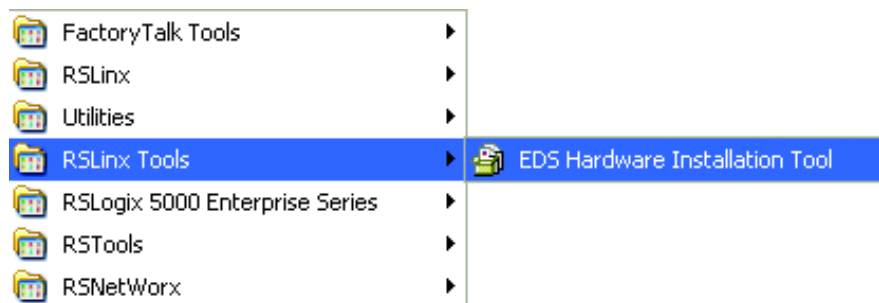

2. Select Add to register a new device.

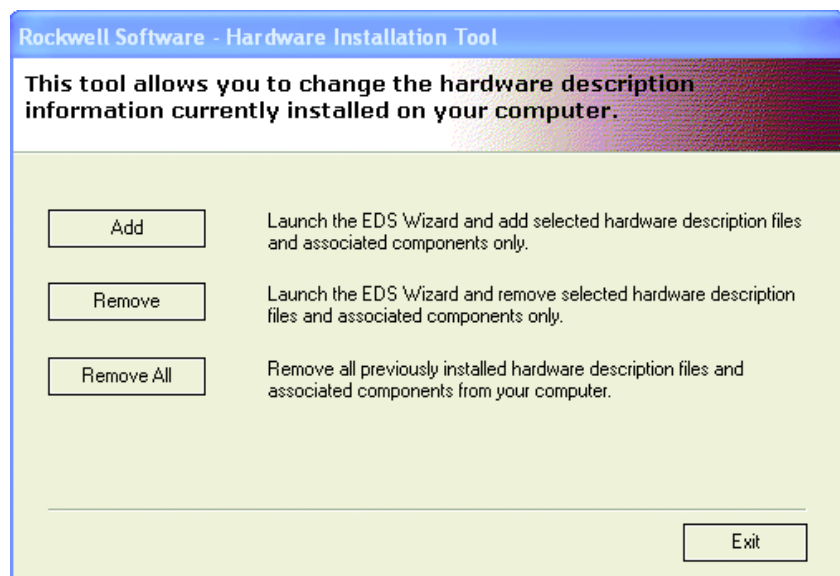

3. Register a single file, browse to the location where the EDS file is located, and select Next.

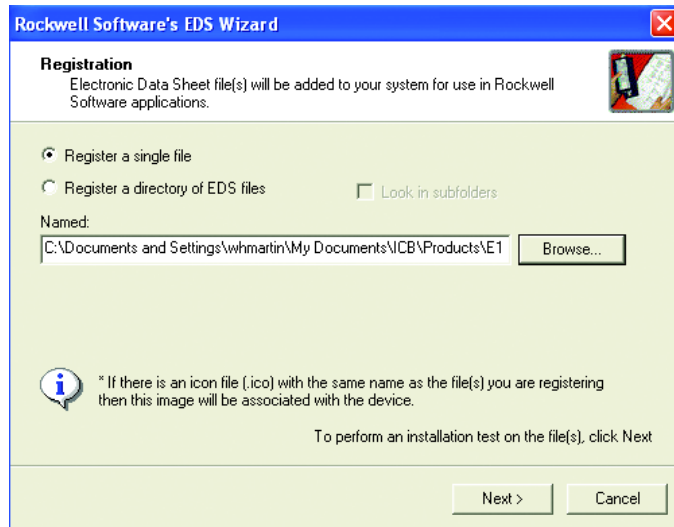

4. Select Next to accept the installation test results.

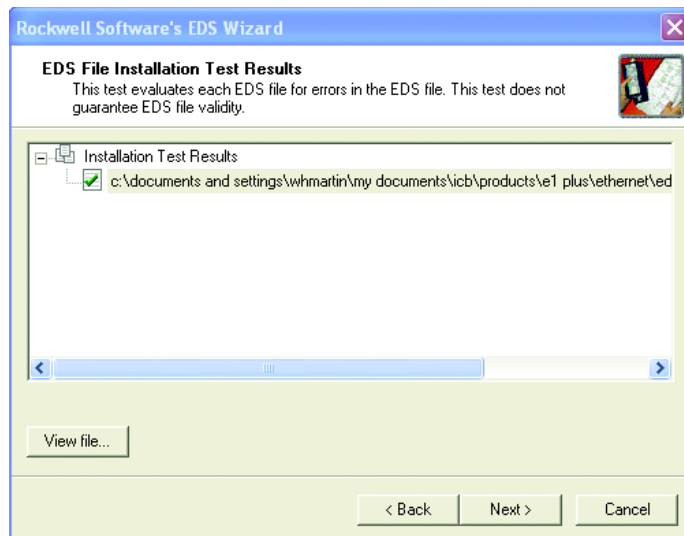

5. Accept the Graphic Image by selecting Next.

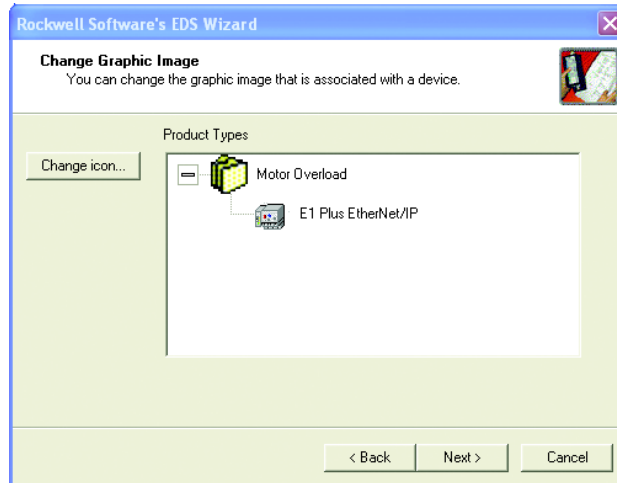

6. Select Next to register the device.

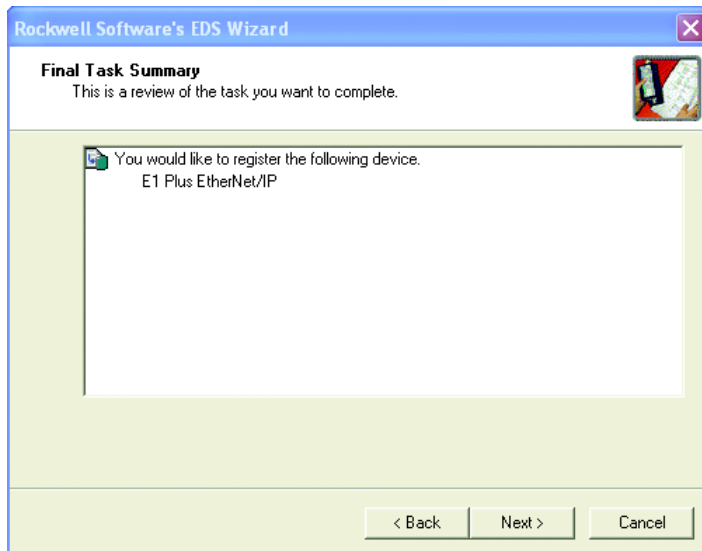

7. Select Finish to successfully register the module.



---

# Automation Controller and Software Communications

## Introduction

The E1 Plus EtherNet/IP Side Mount Module supports three types of EtherNet/IP messaging:

- I/O Messaging — Used for deterministic Ethernet communications with ControlLogix, CompactLogix, SoftLogix, and EtherNet/IP scanners. Its primary use is to read and write I/O data for control purposes.
- Explicit Messaging — Used for non-deterministic communications in which the data is not critical for control. Explicit messages have a lower priority compared to I/O messages, and they are used to read and write non-critical data. Logix controllers, SLC-5/05 processors, and MicroLogix controllers support Explicit Messaging using a MSG instruction.
- ControlLogix Style Tags — Used for non-deterministic communications in which the data will be used in an HMI, SCADA, or historical data logging software system. Software packages can read and write data directly from the device.

This chapter describes and shows examples of how each type of messaging is used.

## I/O Messaging

RSLogix 5000 software is used to configure I/O messaging between an automation controller and an E1 Plus EtherNet/IP Side Mount Module on an EtherNet/IP Network. This example will show the steps necessary to configure a ControlLogix™ controller for this type of messaging.

## ControlLogix Configuration

An existing project can be used or a new project can be created to configure EtherNet/IP I/O messaging. To create a new configuration in RSLogix 5000, select File → New.

1. Select the controller type, chassis type, slot number, and project path. Enter a name for the controller and click OK.

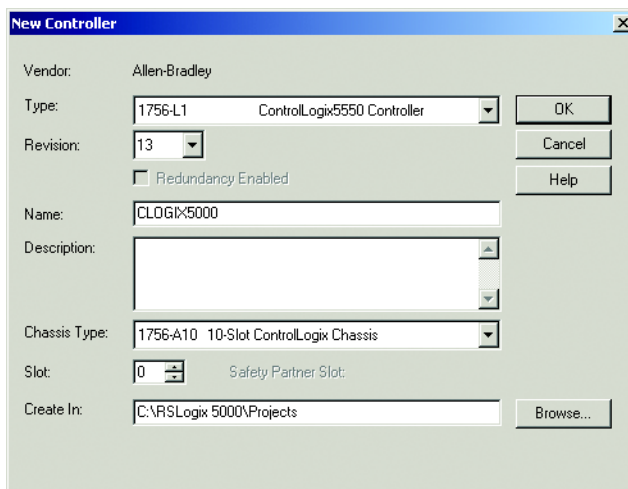

2. Right-click on I/O Configuration and select New Module to open the Select Module Type window.

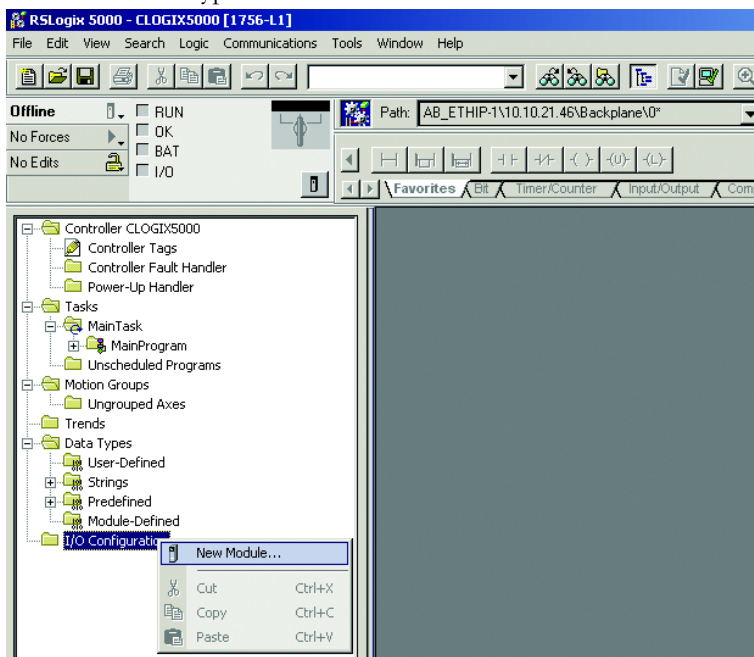

3. Select the desired EtherNet/IP scanner module and click OK.

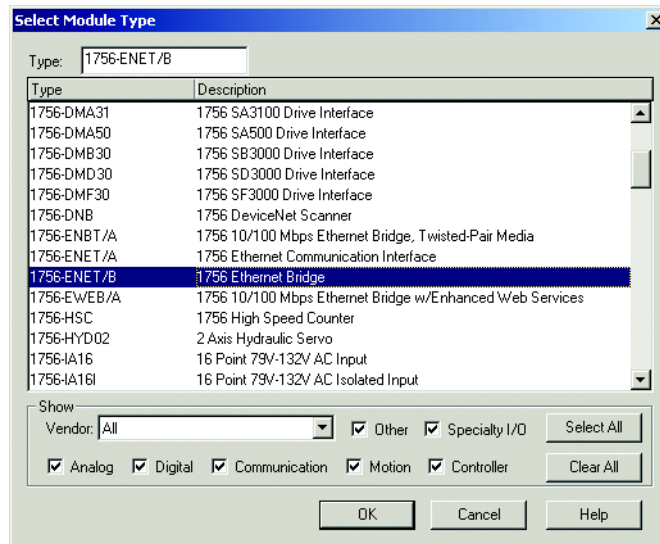

4. Enter the desired communication settings and click Finish.

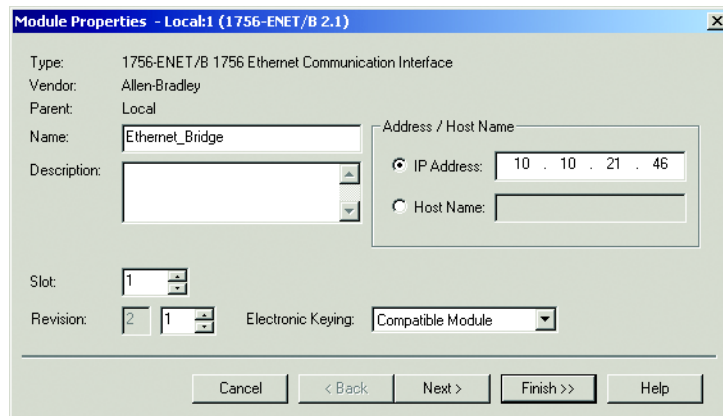

## EtherNet/IP Network Configuration

After the controller configuration, the E1 Plus EtherNet/IP Side Mount Module has to be added to the I/O configuration.

1. Place the program in Offline mode.

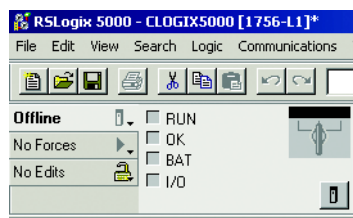

- Right-click on the Ethernet/IP scanner in I/O Configuration and select New Module to open the Select Module Type window.

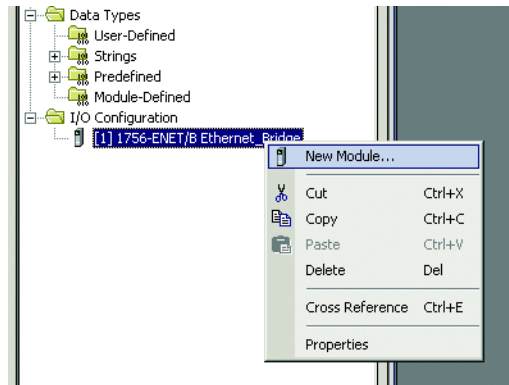

- Select Generic Ethernet Module and click OK.

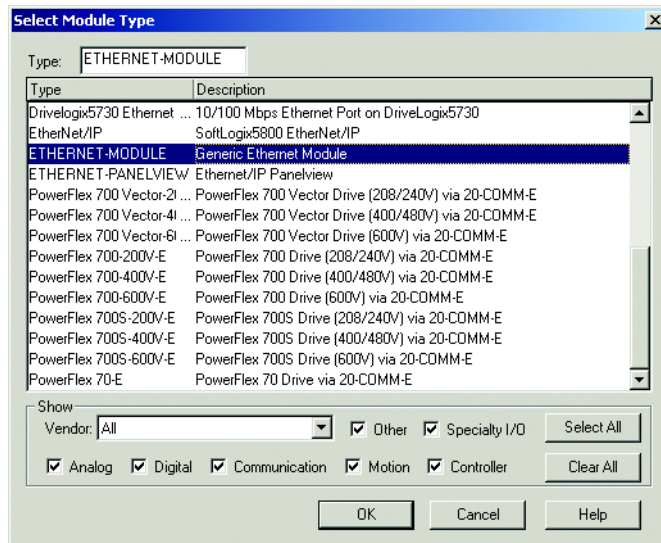

- Enter a name for the E1 Plus EtherNet/IP Side Mount Module. The name will create a tag in RSLogix 5000 that can be used to read and write data from the E1 Plus EtherNet/IP Side Mount Module.

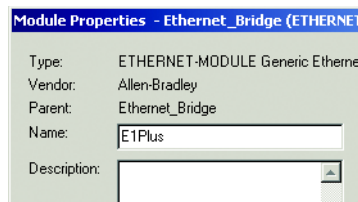



- Select Data-SINT for the Comm Format. The Comm Format tells RSLogix 5000 the format of the data. The Data-SINT format will represent the data from the E1 Plus EtherNet/IP Side Mount Module as a field of 8-bit values.



- Set the Connection Parameters. I/O data is accessed using Input Instances 50, 51, 106, 110 or 111 and Output Instances 2, 101 or 103. The size of the input connection and the output connection shall correspond to the size of the chosen instance. The E1 Plus configuration assembly instance is 120. In this example configuration data is not used, so the data size is set to 0.

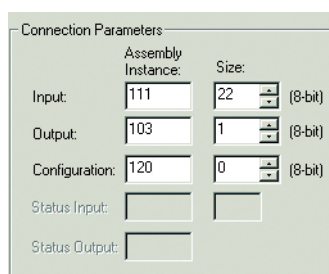

- Enter the IP address of the E1 Plus EtherNet/IP Side Mount Module.

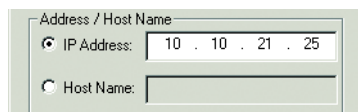

- Click Next.
- Enter a value for the time between each scan of the module. Make sure Inhibit Module is not checked.

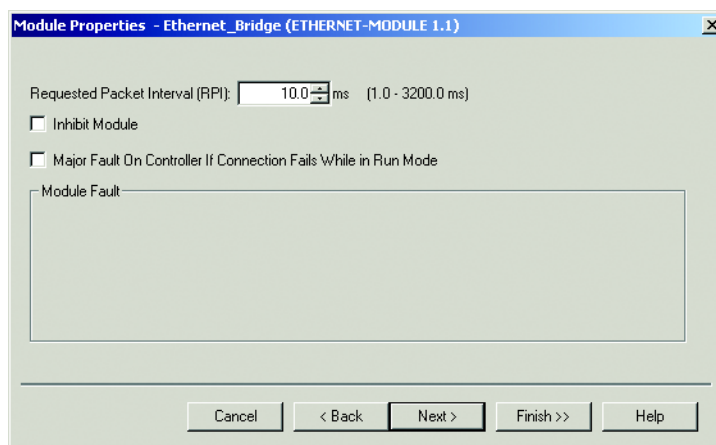

- Click Finish to add the E1 Plus to the I/O Configuration in RSLogix 5000.

## Downloading the Configuration to the PLC

1. In the RSLogix 5000 program, select Communications → Who Active.

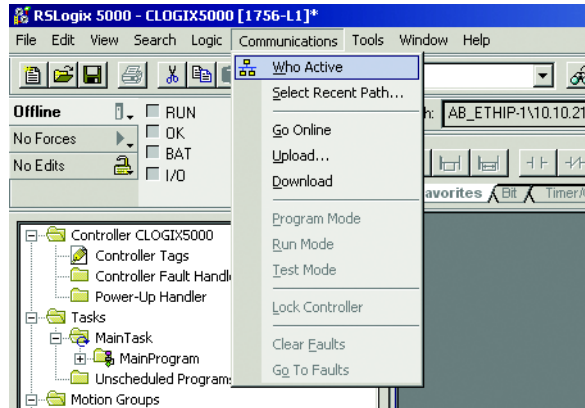

2. Select the desired communication path and click Set Project Path.

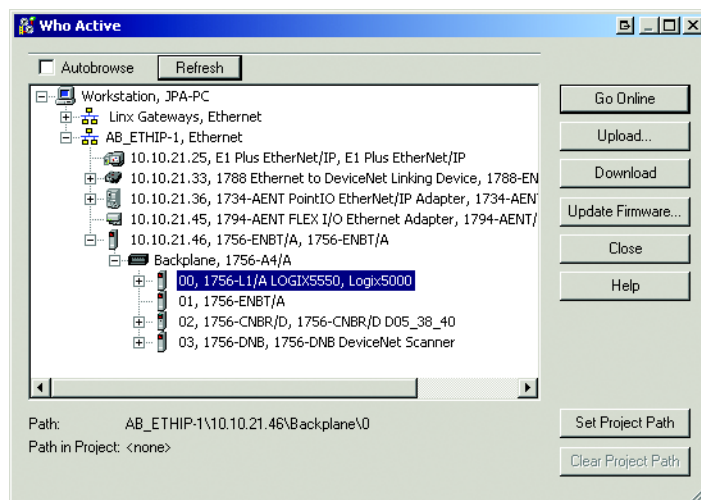

3. Select Communications → Go Online.

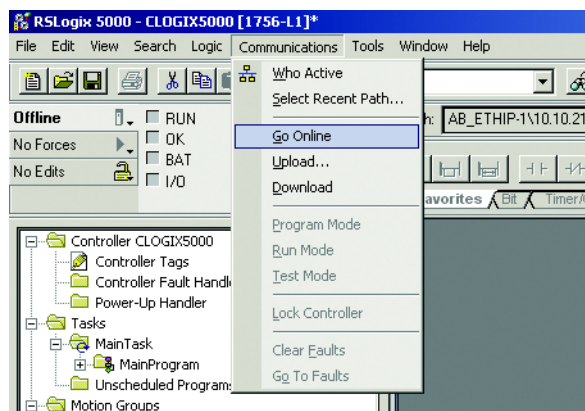

4. In the Connected To Go Online window, click Download.

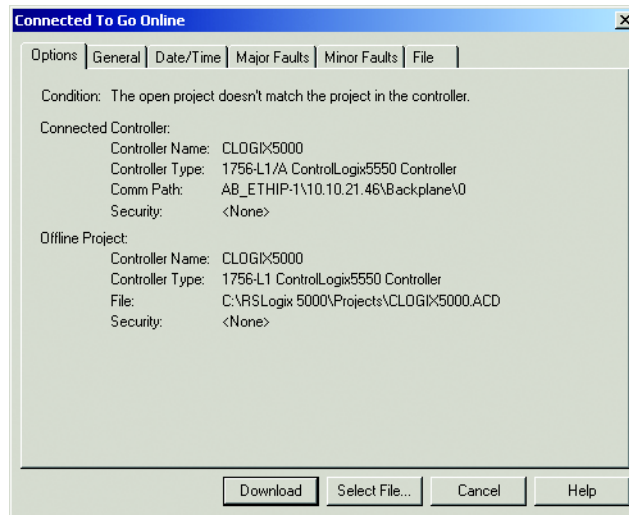

5. In the Download confirmation window, click Download to download the configuration to the PLC.

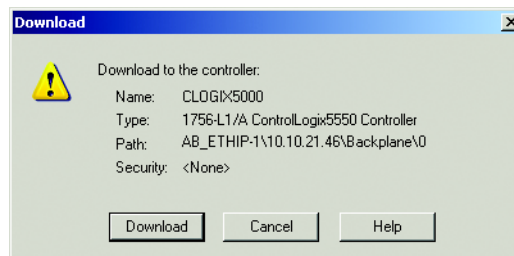

If there are any errors, a warning triangle will be present on the E1 Plus in the I/O configuration listing.

Double-click the module to view any error that is reported.

## Accessing Module Data

With both the controller and EtherNet/IP network configured, the ControlLogix controller can exchange data with the E1 Plus EtherNet/IP Side Mount Module.

1. Go online and switch the controller to Remote Run mode.

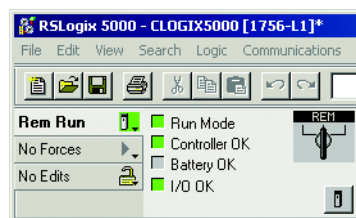

2. Open the Controller Tags window.

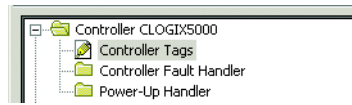

3. Select the Monitor Tags tab.

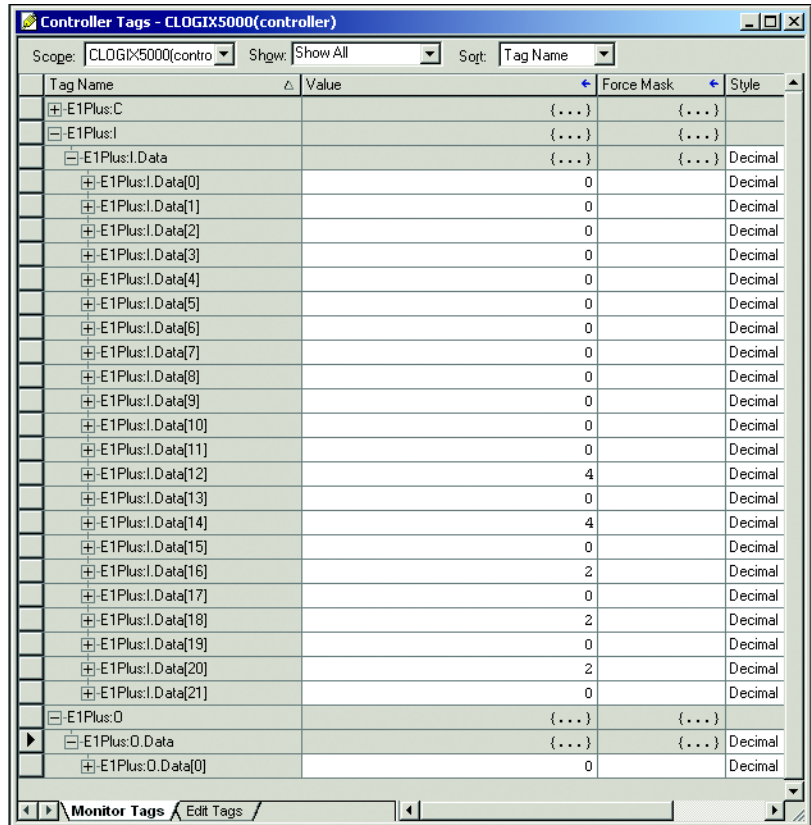

Three tags, "E1Plus:C", "E1Plus:I" and "E1Plus:O", have been added to represent the three I/O Instances: Configuration, input and output. The Configuration Instance was created even though its size was configured as zero. The E1Plus:I tag represents input data, which is data coming from the E1Plus into the controller (%FLA, %TCU, Trip Status, Warning Status, etc.). The E1 Plus:O tag represents output data, which is data going from the controller out to the E1 Plus (Enable Output A, Trip Reset, etc.).

## Logix Explicit Messaging

CompactLogix, ControlLogix, and SoftLogix controllers can read and write specific information to and from the E1 Plus EtherNet/IP Side Mount Module using Explicit Messaging and the Parameter Object. An example of configuring a ControlLogix explicit message using the MSG instruction to read the Device Status parameter data from the E1 Plus EtherNet/IP Side Mount Module is shown below.

1. Configure the configuration tab for the message instruction with the following settings:

- Message type: CIP Generic
- Service type: Parameter Read
- Instance: 10: The parameter you want to read back (e.g., 10 represents device status)
- Destination: The controller tag to write the data to.

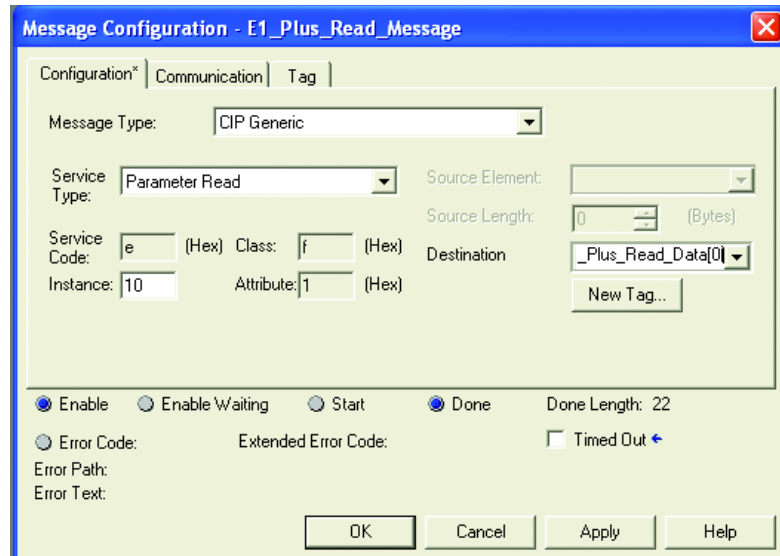

2. Configure the path field in the communications tab to point to the E1 Plus EtherNet/IP Side Mount Module.

Path: **1, 2, 2, 192.168.0.100**

For this example, **1** represents the processor slot, **2** represents the EtherNet/IP scanner slot, **2** represents the EtherNet/IP port, and **192.168.0.100** represents the IP address of the E1 Plus EtherNet/IP Side Mount Module.

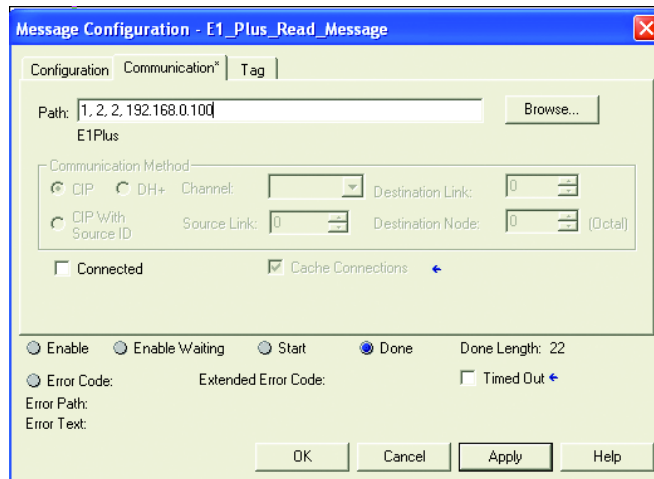

Users can read all of the motor diagnostic data back in one MSG instruction by using Assembly Instance 111. An example of configuring a ControlLogix explicit message using the MSG instruction to read all of the motor diagnostic data from the E1 Plus EtherNet/IP Side Mount Module is shown below.

1. Configure the configuration tab for the message instruction with the follow settings:

- Message type: CIP Generic
- Service type: Get Attribute Single
- Class: 4 – the Assembly Object
- Instance: 111 - the Complete Motor Starter assembly
- Destination: The controller tag to write the data to.
- Attribute: 3 – get/set data instance attribute

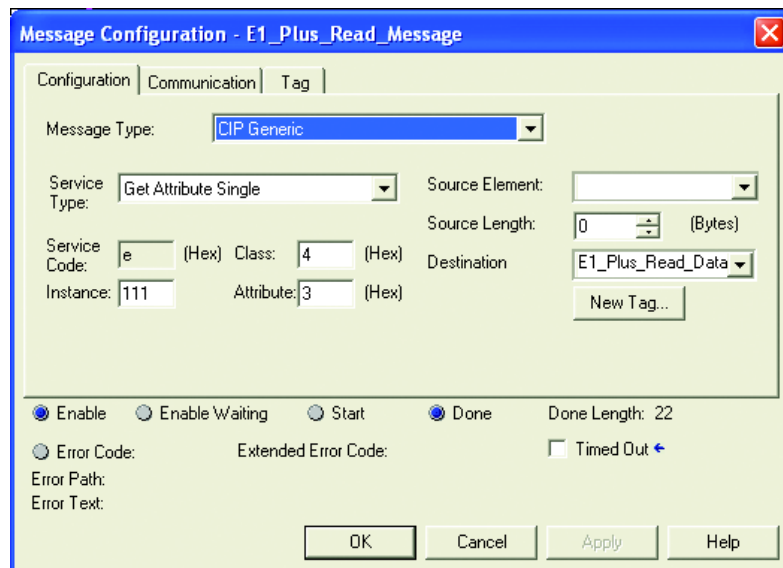

2. Configure the path field in the communications tab to point to the E1 Plus EtherNet/IP Side Mount Module.

Path: **1, 2, 2, 192.168.0.100**

For this example, **1** represents the processor slot, **2** represents the EtherNet/IP scanner slot, **2** represents the EtherNet/IP port, and **192.168.0.100** represents the IP address of the E1 Plus EtherNet/IP Side Mount Module.

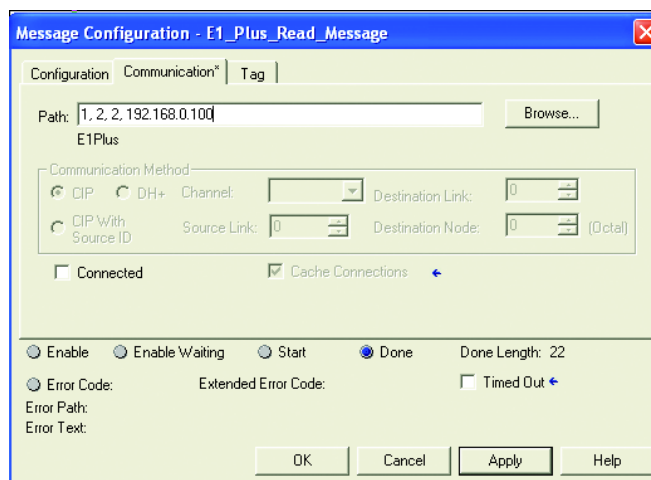

## MicroLogix and SLC-5/05 Explicit Messaging

MicroLogix and SLC-5/05 controllers can read and write information to and from the E1 Plus EtherNet/IP Side Mount Module using Explicit Messaging and the Assembly Object. RSLogix 500 Version 8.10 or higher is required to configure EtherNet/IP explicit messaging with these controllers.

An example of a MicroLogix 1100 using the MSG instruction to read all of the motor diagnostic data from the E1 Plus EtherNet/IP Side Mount Module is shown below.

1. Write the appropriate ladder logic to periodically execute a MSG instruction for the MicroLogix controller (an EEM instruction for the SLC-5/05).

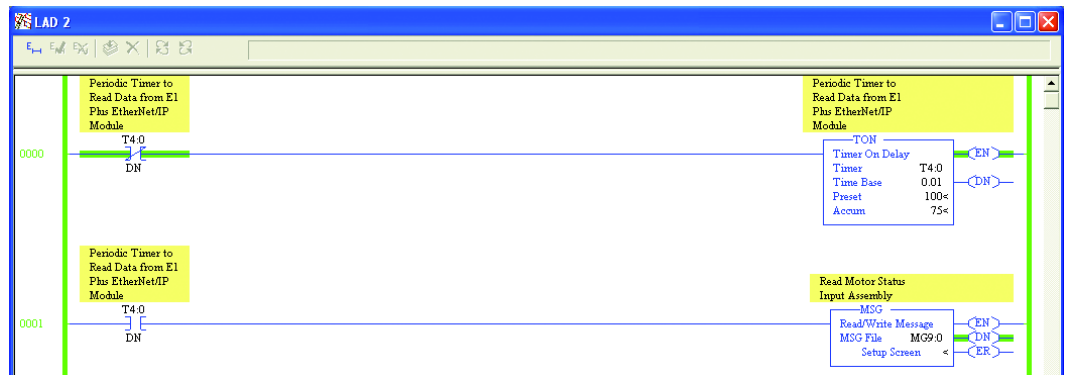

2. Configure General tab in the MSG instruction with the following parameters:

- Channel: 1 (Integral) - the Ethernet port on the processor
- Communication Command: CIP Generic
- Data Table Address: the location to store the information
- Size in Bytes: 22 – assembly 111 consists of 22 bytes of information
- MultiHop: Yes
- Service: Read Assembly – to read an input assembly
- Class: 4 – the Assembly Object
- Instance: 111 – the Complete Motor Starter assembly
- Attribute: 3 – get/set data instance attribute

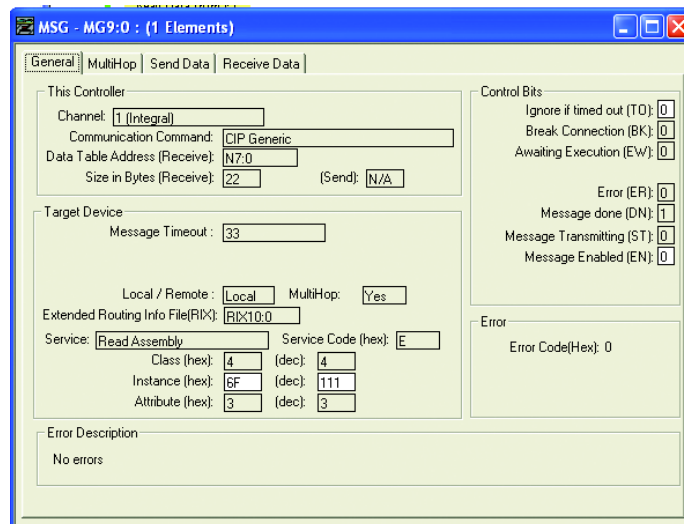

3. Configure MultiHop tab in the MSG instruction with the following parameters:

To Address: the IP address of the E1 Plus EtherNet/IP Side Mount Module.



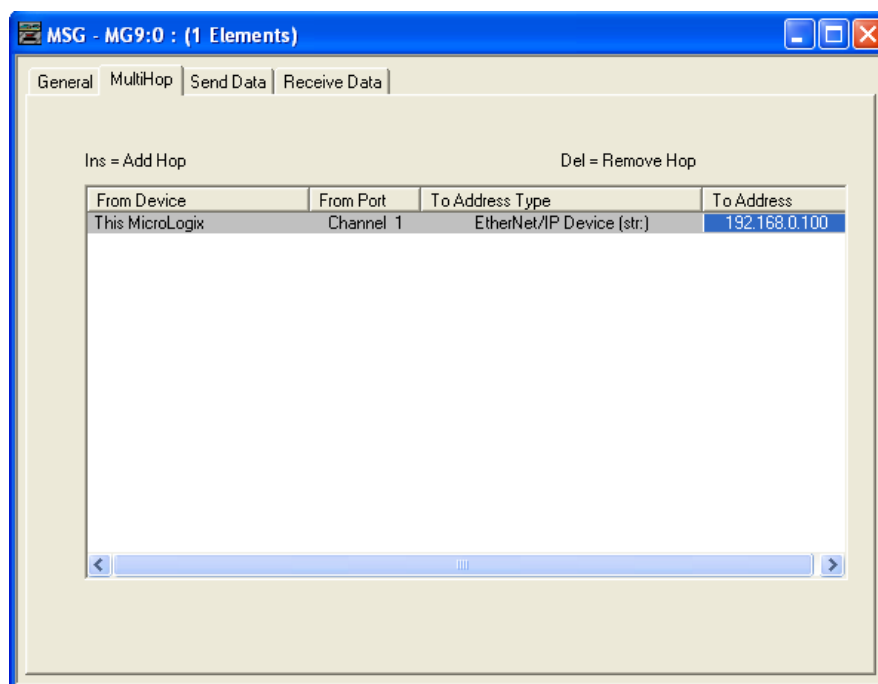

An example of a MicroLogix 1100 using the MSG instruction to write data to energize an output relay on the E1 Plus EtherNet/IP Side Mount Module is shown below.

1. Write the appropriate ladder logic to execute a MSG instruction for the MicroLogix controller (an EEM instruction for the SLC-5/05) to control the E1 Plus EtherNet/IP Side Mount Module.

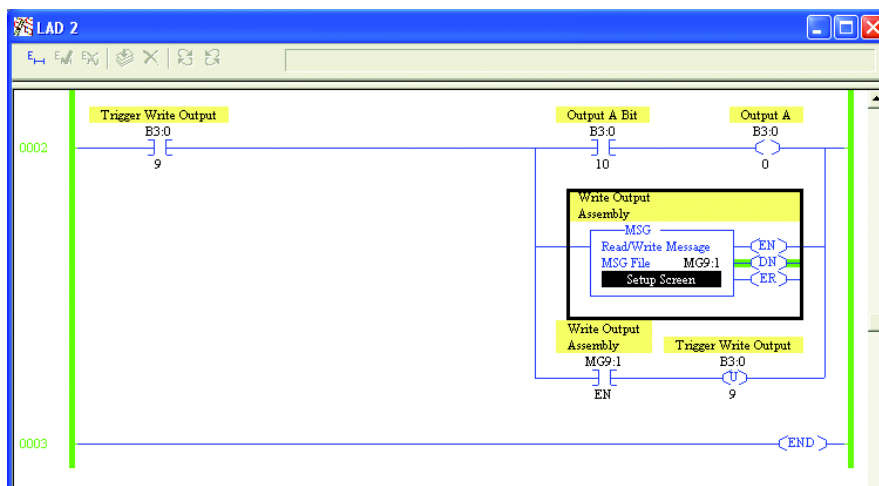

2. Configure General tab in the MSG instruction with the following parameters:
  - Channel: 1 (Integral) - the Ethernet port on the processor
  - Communication Command: CIP Generic

- Data Table Address: the location to write the information from
- Size in Bytes: 1 – assembly 101 consists of 1 byte of information
- MultiHop: Yes
- Service: Write Assembly – to write an output assembly
- Class: 4 – the Assembly Object
- Instance: 101 – the Basic Contact output assembly
- Attribute: 3 – get/set data instance attribute

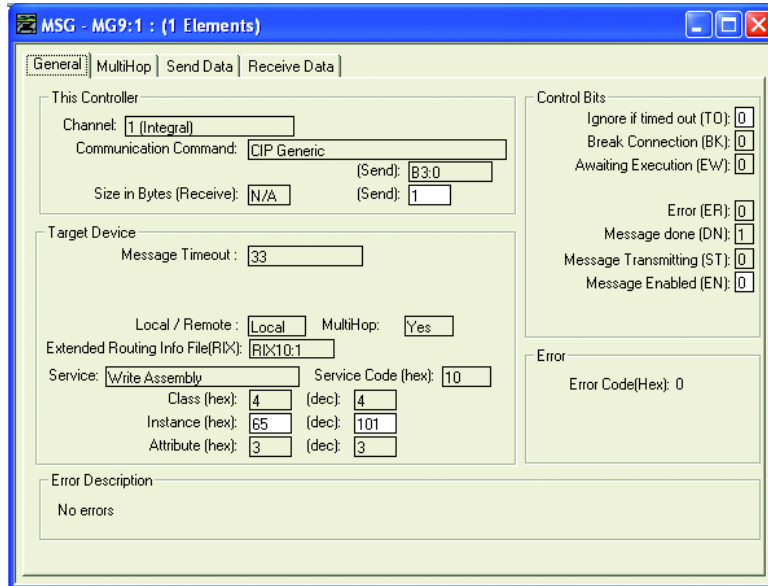

3. Configure the MultiHop tab in the MSG instruction with the following parameters:

To Address: the IP address of the E1 Plus EtherNet/IP Side Mount Module.

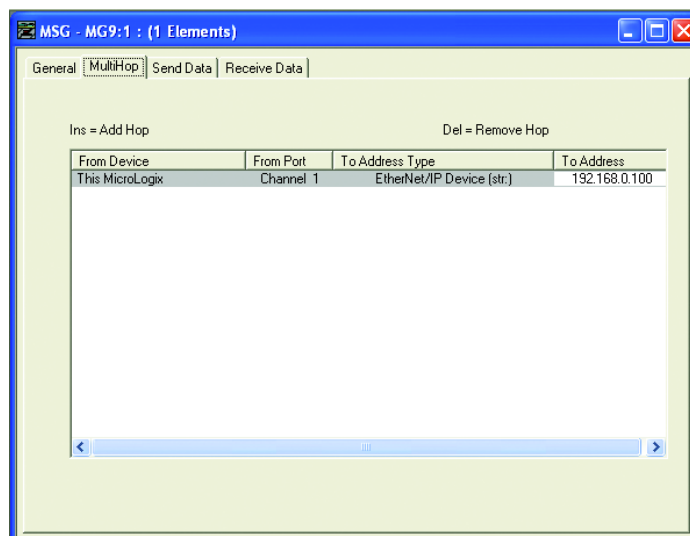

## FactoryTalk View with Predefined Tags

The E1 Plus EtherNet/IP Side Mount Module embedded predefined CIP tags within the module. This allows software packages, such as FactoryTalk View Supervisory Edition (SE), to read and write data directly from the E1 Plus EtherNet/IP Side Mount Module. An example of using RSLinx Classic as an OPC (OLE for Process Control) server to serve data to FactoryTalk View SE is show below. Follow these steps to read data directly from the E1 Plus EtherNet/IP Side Mount Module using its predefined tags.

1. Configure an OPC topic within RSLinx Classic to communicate to the E1 Plus EhterNet/IP Side Mount Module. In the Data Source tab, select *New* to create a new OPC topic name, high light the device to establish communications with, and press *Apply*.

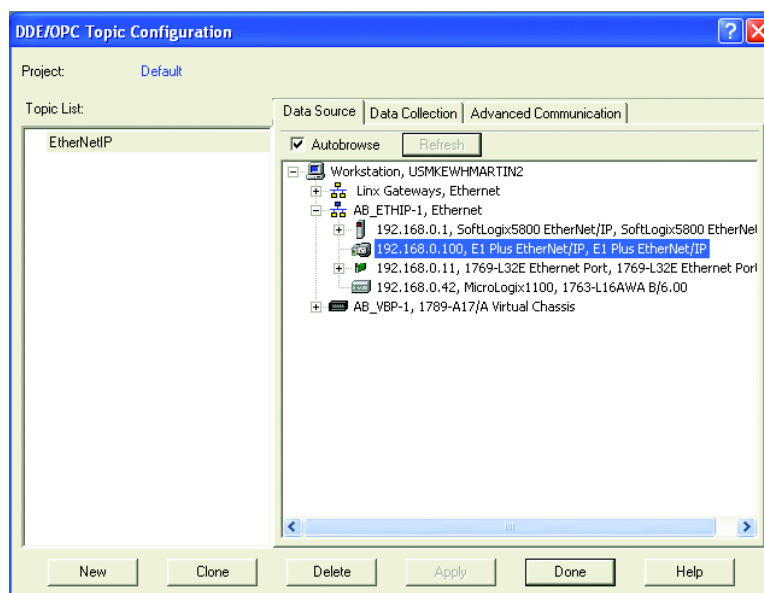

2. In the Data Collection tab, select the process type *Logix5000* and select *Apply*

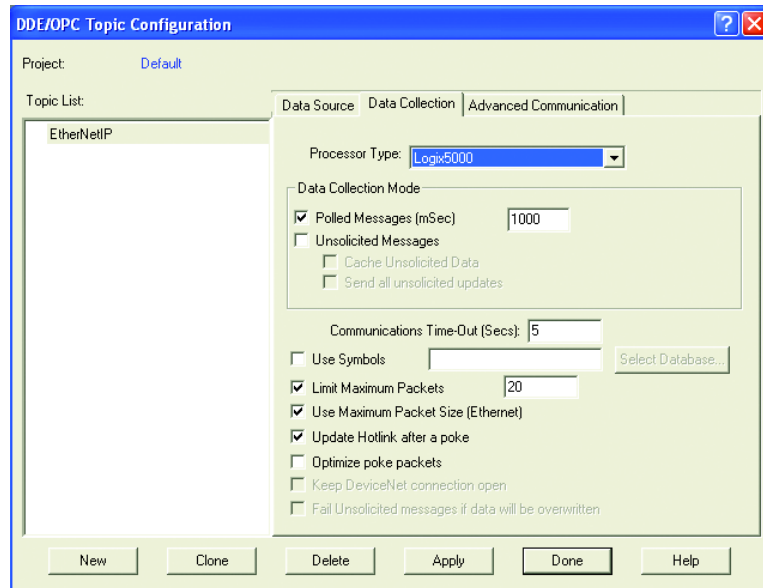

3. Start FactorTalk View Studio and create a new application. Draw a numeric display. Right click on the display and select *Connections*.

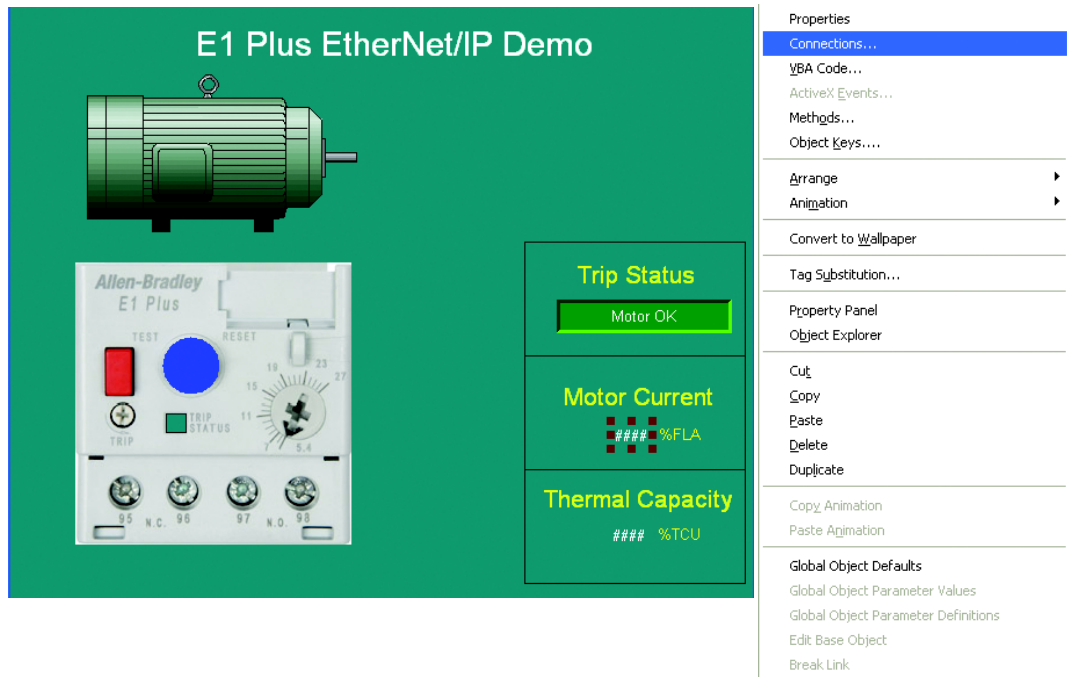

4. Select the Tag selector tool  to select a tag from the E1 Plus EtherNet/IP Side Mount Module.

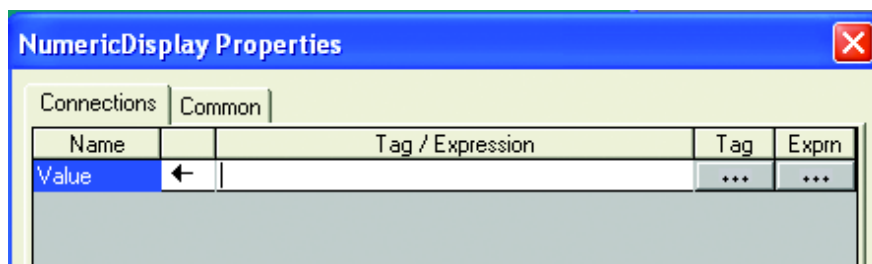

- Right click on the project name and select *Refresh All Folders* to get an updated list of topics to read data from.

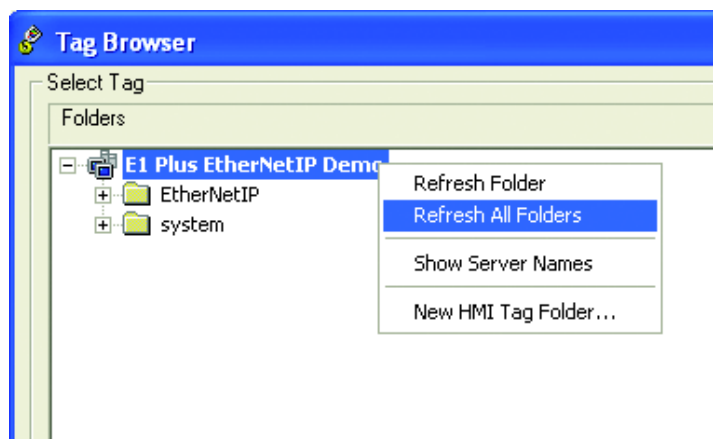

- Expand the OPC topic name that you created in RSLinx Classic, select the *Online* folder, choose the tag you would like to display in the numeric display, and press *OK*.

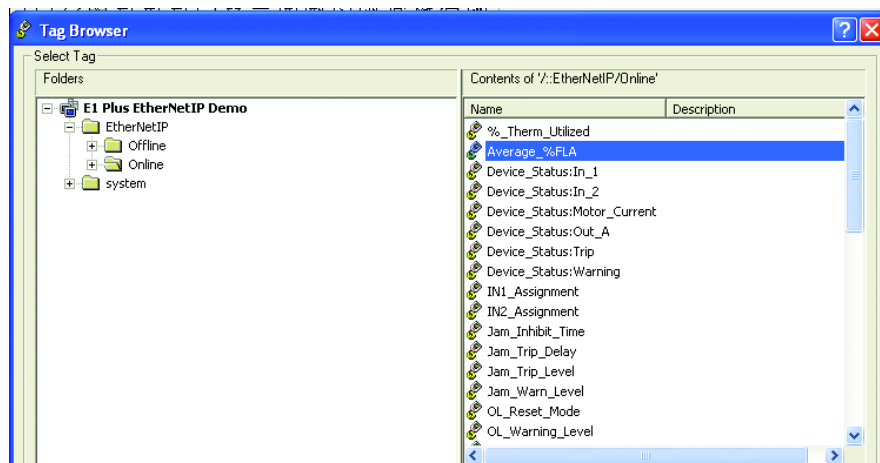

7. Select *OK* to select the tag to display in the numeric display.

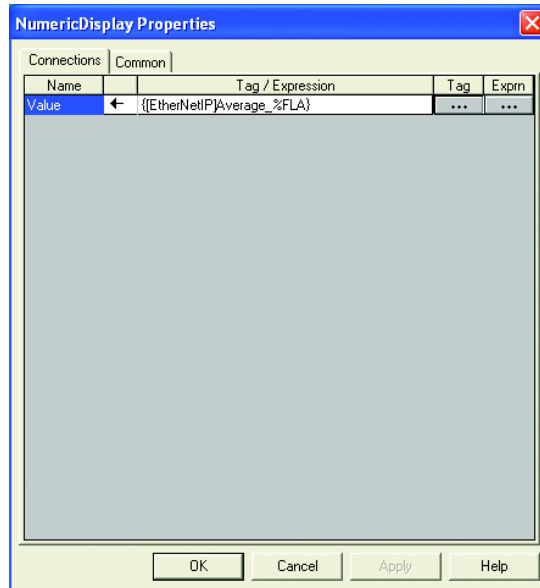

8. Test the display by pressing the Test Run button  to view data directly from the E1 Plus EtherNet/IP Side Mount Module on the display.

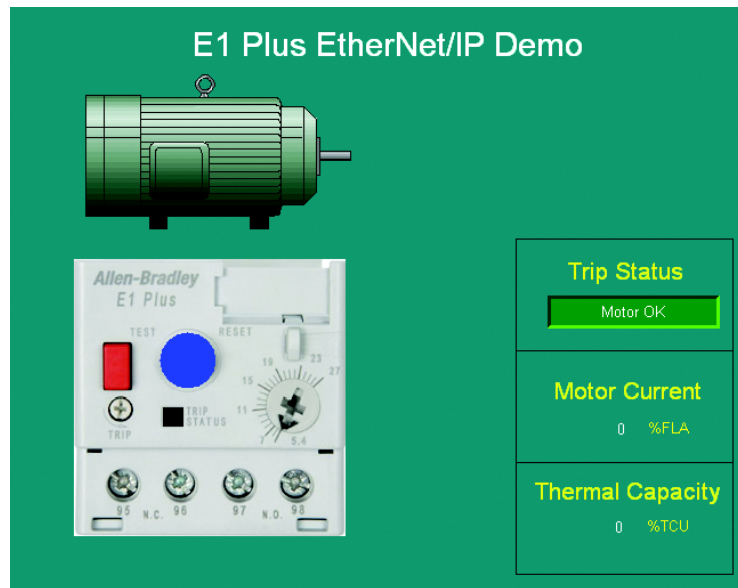

## Email Notifications

### Introduction

This chapter describes email notifications and how to configure an E1 Plus EtherNet/IP module to send email notifications for different events.

### Notification Events

There are several events that can trigger an email notification; the events are listed below.

- Overload trip
- Phase loss trip
- Jam trip
- Trip clear
- Overload warning
- Jam warning
- Underload warning
- Communication fault warning
- Communication idle warning
- EEPROM fault warning
- Warning clear

---

**IMPORTANT**

If an event has been disabled within the Control Supervisor Attribute 108 or 109 (see page B-11), it is not possible to override this and have emails generated.

---

### Email Contents

The subject and body contents in the email message will be created from the type of trip or warning that is detected, the Device Name, Device Description, Device Location and Contact Info. Sample email messages are shown here:

**Email Subject**

E1Plus module has detected a trip

**Email Body**

Trip status: Overload

Device Name: E1 Plus EtherNet/IP Side Mount Module

### Email Subject

Device Description: Module under development  
Device Location: The Location  
Contact Info: Contact Person  
                  contact.person@thecontact.com

The first word in the subject is the Device Name. If a Device Name is not configured, then the product name attribute from the identity object will be used.

## Email Configuration

To be able to send an email, the IP address or the hostname of a Simple Mail Transfer Protocol (SMTP) server must be configured and notifications must be selected. Follow these steps to configure an email notification.

1. In a web browser, enter the IP address of the E1 Plus EtherNet/IP module in the address bar and press Enter.

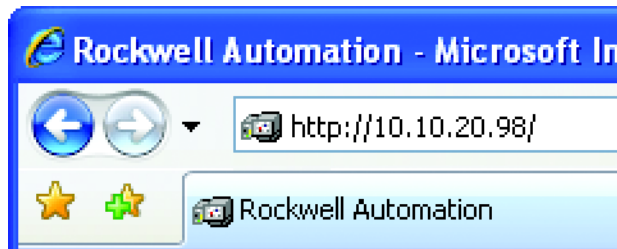



2. Select Administrative Settings → email Configuration, and a login window will appear.

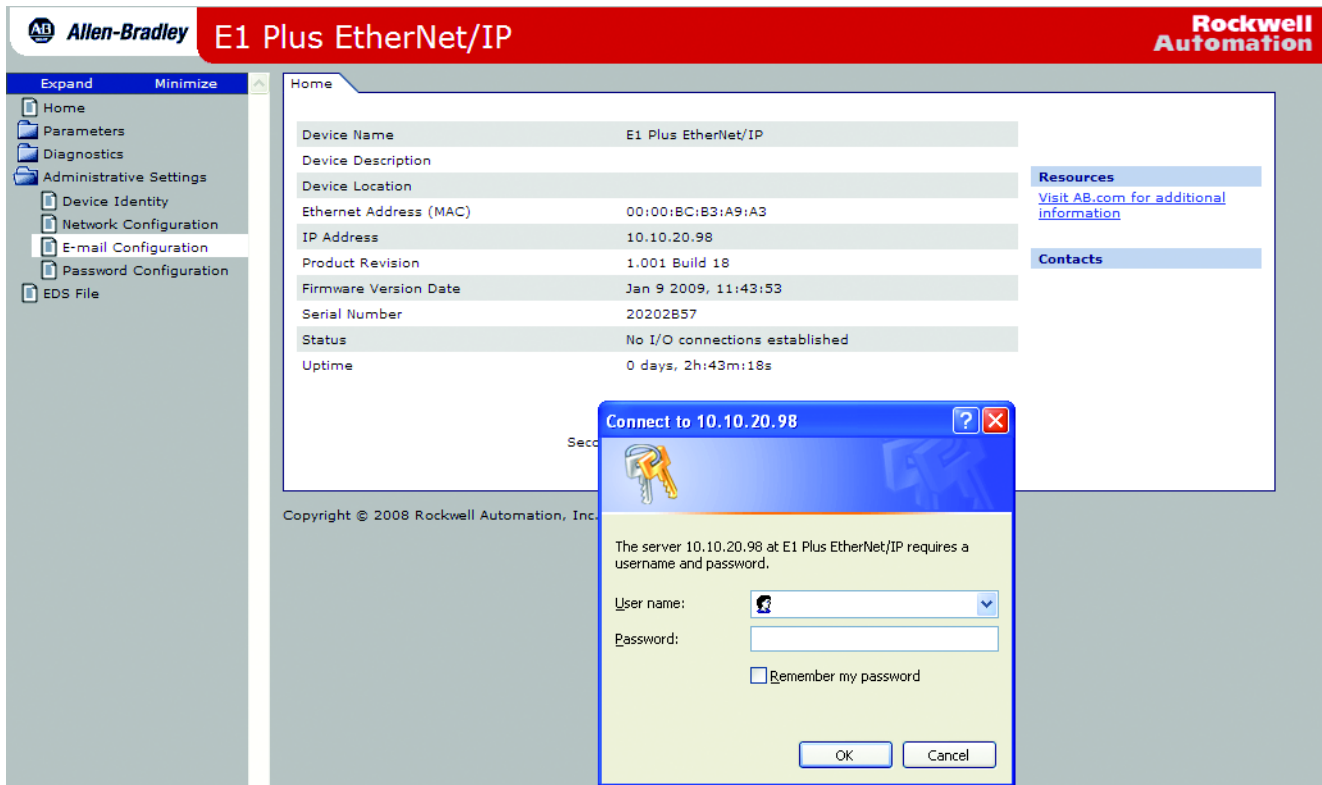

3. Log in with the username "Administrator" and no password. If desired, a password can be set within the Administrative Settings tab *Password Configuration*.

4. Enter the information into the email notification fields as described below.

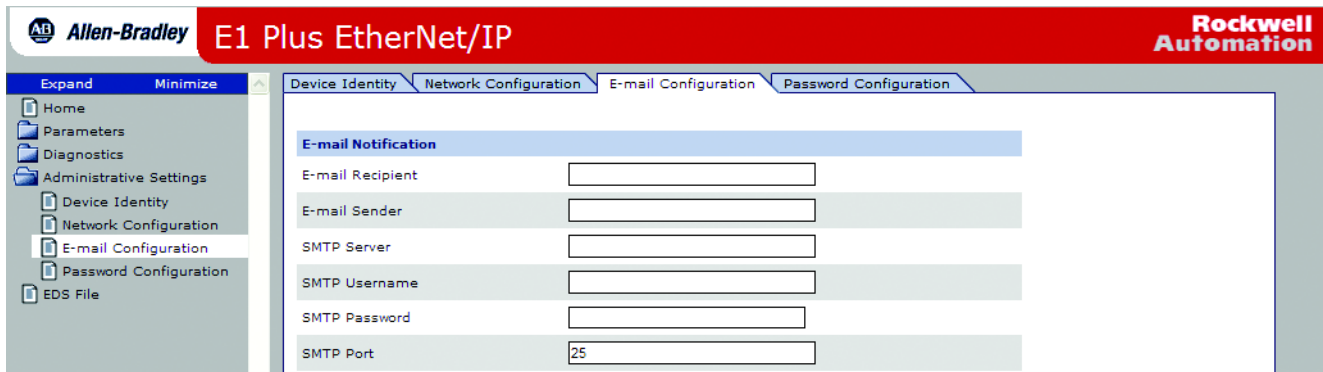

- Email Recipient** The email address of the person who will receive the notifications.
- Email Sender** The email address from which the notification will be sent.
- SMTP Server** The SMTP server address. Ask your network administration what address to use.
- SMTP Username** The username for the SMTP server. Ask your network administration what username to use.
- SMTP Password** The password for the SMTP server. Ask your network administration what password to use.
- SMTP Port** The SMTP Server Port. Ask your network administration what port number to use (Port 25 is a common SMTP port).

5. Select the specific fault and warning notifications to send to the email recipient. These can be changed after the initial configuration.

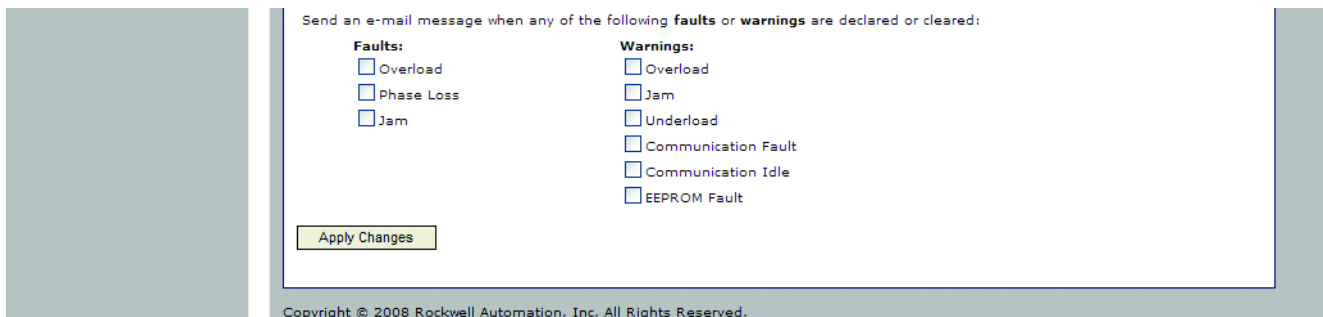

6. Click "Apply Changes" to save the configuration.

## Configure Device Identity

The Device Identity properties populate the notification email subject and body. To configure the Device Identity, perform these steps:

1. In a web browser, enter the IP address of the E1 Plus EtherNet/IP module in the address bar and press Enter.

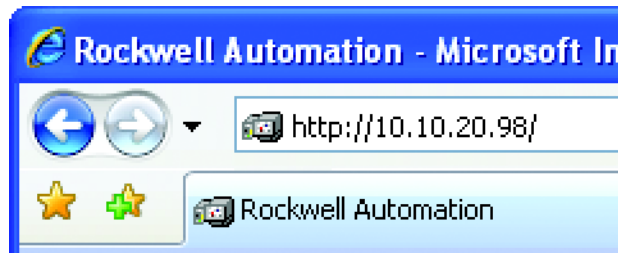

2. Select Administrative Settings → Device Identity and a login window will appear.

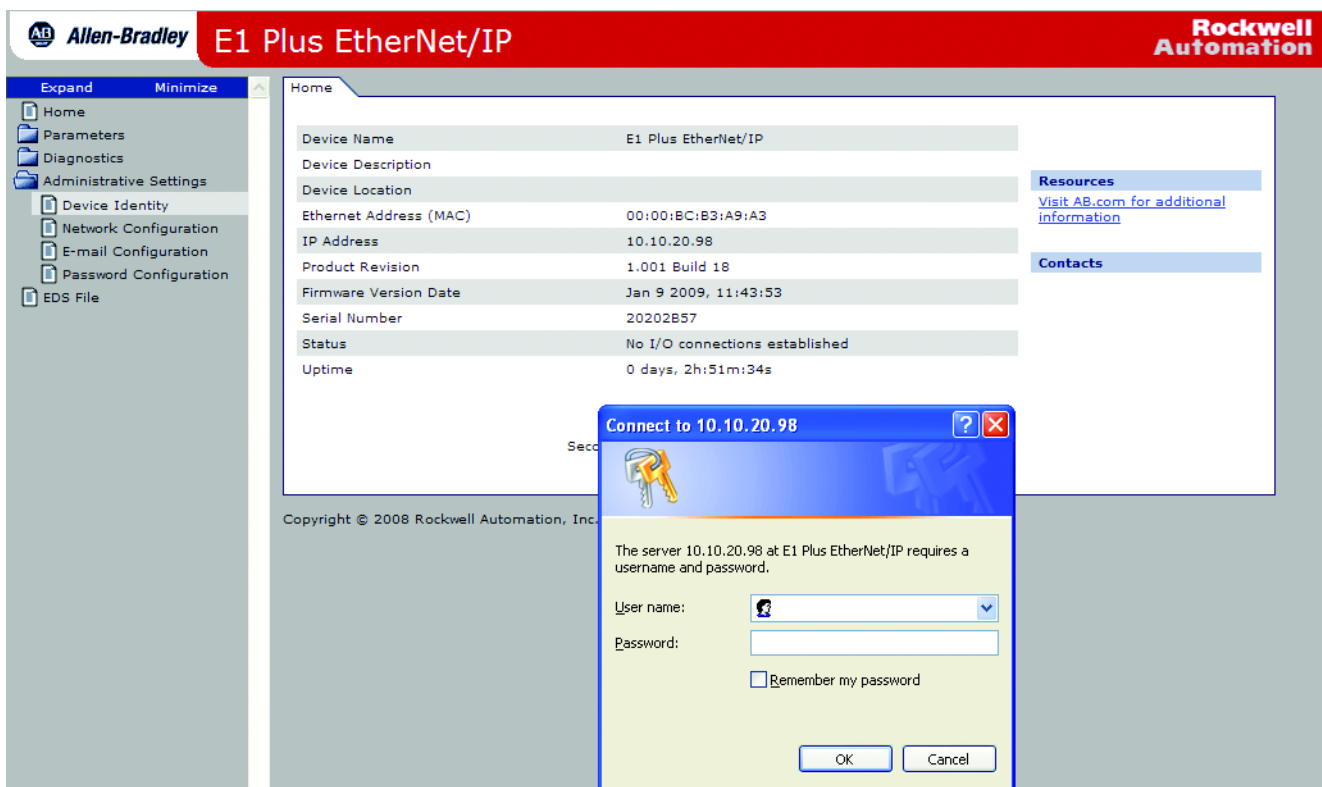

3. Log in with the username "Administrator" and no password. If desired, a password can be set within the Administrative Settings tab *Password Configuration*.

4. Enter the Device Identity information into the fields as described below.

The screenshot shows the configuration software for the E1 Plus EtherNet/IP module. The interface is titled 'E1 Plus EtherNet/IP' and includes the Allen-Bradley and Rockwell Automation logos. A navigation pane on the left lists various settings categories. The main configuration area is titled 'Device Identity' and contains a section for 'Name and Contact Information'. This section includes five input fields: 'Device Name', 'Device Description', 'Device Location', 'Contact Info', and another 'Contact Info' field. An 'Apply Changes' button is located at the bottom of the configuration area. The copyright notice at the bottom reads 'Copyright © 2008 Rockwell Automation, Inc. All Rights Reserved.'

<b>Device Name</b>	The name of the E1 Plus EtherNet/IP module.
<b>Device Description</b>	The description of the E1 Plus EtherNet/IP module.
<b>Device Location</b>	The location of the E1 Plus EtherNet/IP module.
<b>Contact Info</b>	Contact information for the E1 Plus EtherNet/IP module.

5. Click "Apply Changes" to save the configuration.

## Limitations

Based on the functionality of the E1 Plus EtherNet/IP module there are some limitations on when emails can be triggered.

- If two events occur at the same time, an email will only be sent for the most significant event.
- If the module has been configured to send an email for a lower prioritized event and this event occurs at the same time as a higher prioritized event for which the module has not been programmed to send an email, no email will be sent for either event.
- The Clear email will only be sent when all events have been cleared and an event email has previously been sent. For example: if the module is configured to send an email when a jam trip is detected and it detects an overload trip for which no email notification is configured, no email will be sent when the overload event is cleared.

## Device Parameters and Tags

### Introduction

The E1 Plus EtherNet/IP Side Mount Module allows the Parameter Object to respond to explicit messages using the MSG instruction from Logix Controllers and SLC-500/MicroLogix controllers. The module also supports the Symbolic Object, which allows software packages such as FactoryTalk View to communicate directly to the E1 Plus EtherNet/IP Side Mount Module as if it were a Logix Controller with predefined tags. This chapter describes each parameter and tag.

### Parameter and Tag Programming

Refer to Chapter 3, *Configure an E1 Plus EtherNet/IP Module To Operate on the Network*, for instructions to modify EtherNet/IP parameter settings.

---

**IMPORTANT**

Parameter setting changes to the E1 Plus EtherNet/IP Module take effect immediately even during a “running” status.

---

### Program Lock

Parameter 24, *Program Lock*, provides a degree of security from having parameter settings unintentionally altered when programmed to the “locked” setting.

### Resetting to the Factory Default Values

Parameter 25, *Set to Default*, allows the installer to reset all parameter settings (including trip logs) to the factory default values.

---

**IMPORTANT**

Resetting to factory default values also resets the E1 Plus EtherNet/IP Module’s IP and DHCP settings.

---

## Parameter Group Listing

The E1 Plus EtherNet/IP Module contains five parameter groups

**Table 6.1 Parameter Groups**

Monitor parameters	Advanced Setup	Reset/Lock	I/O Setup	Trip History
<b>1</b> Average %FLA	<b>12</b> Trip Enable	<b>14</b> Trip Reset	<b>34</b> OutA Pr FltState	<b>5</b> Trip Log 0
<b>2</b> %Therm Utilized	<b>13</b> Warning Enable	<b>24</b> Program Lock	<b>35</b> OutA Pr FltValue	<b>6</b> Trip Log 1
<b>3</b> Trip Status	<b>15</b> Single/Three Ph	<b>25</b> Set to Default	<b>36</b> OutA En FltState	<b>7</b> Trip Log 2
<b>4</b> Warning Status	<b>16</b> OL Reset Mode		<b>37</b> OutA En FltValue	<b>8</b> Trip Log 3
<b>10</b> Device Status	<b>17</b> OL Warning Level		<b>38</b> OutA En IdlState	<b>9</b> Trip Log 4
	<b>18</b> Jam Inhibit Time		<b>39</b> OutA En IdlValue	
	<b>19</b> Jam Trip Delay		<b>40</b> IN1 Assignment	
	<b>20</b> Jam Trip Level		<b>41</b> IN2 Assignment	
	<b>21</b> Jam Warn Level			
	<b>22</b> UL Inhibit Time			
	<b>23</b> UL Warn Level			

## Monitor Group

Average %FLA	Parameter No.	1
This parameter reports the average motor current. The value is reported as a percentage of motor rated current (dial setting on the E1 Plus Overload Relay), and is reported in increments of 5.	Access Rule	Get
	Data Type	UINT
	Units	%
	Min. Value	0
	Max. Value	1275
	Default Value	0
	Tag Name	Average_%FLA

% Therm Utilized	Parameter No.	2
This parameter reports the percent thermal utilization of the connected motor.	Access Rule	Get
	Data Type	USINT
	Units	%
	Min. Value	0
	Max. Value	100
	Default Value	None
	Tag Name	%_Therm_Utilized

<b>Trip Status</b>	<b>Parameter No.</b>	<b>3</b>
This parameter provides trip identification.  1 = Trip 0 = No Trip  Bit 0: Overload — Tag Name: Trip_Status: Overload Bit 1: Phase Loss — Tag Name: Trip_Status: Phase_Loss Bit 2: Jam — Tag Name: Trip_Status: Jam	Access Rule	Get
	Data Type	WORD
	Units	—
	Min. Value	0x0000
	Max. Value	0x0007
	Default Value	0x0000
<b>Warning Status</b>	<b>Parameter No.</b>	<b>4</b>
This parameter provides warning identification  1 = Warning 0 = No Warning  Bit 0: Overload — Tag Name: Warning_Status: Overload Bit 2: Jam — Tag Name: Warning_Status: Jam Bit 3: Underload — Tag Name: Warning_Status: Underload Bit 5: Comm Fault — Tag Name: Warning_Status: Comm_Fault Bit 6: Comm Idle — Tag Name: Warning_Status: Comm_Idle Bit 7: Non Vol Mem Fault — Tag Name: NV_Mem_Fault	Access Rule	Get
	Data Type	WORD
	Units	—
	Min. Value	0x0000
	Max. Value	0x00FF
	Default Value	0x0000
<b>Device Status</b>	<b>Parameter No.</b>	<b>10</b>
This parameter provides status information related to the E1 Plus Overload Relay and the SMM.  1 = On or Present 0 = Off or Not Present  Bit 0: Trip — Tag Name: Device_Status: Trip Bit 1: Warning — Tag Name: Device_Status: Warning Bit 2: Output A — Tag Name: Device_Status: Out_A Bit 3: Input #1 — Tag Name: Device_Status: In_1 Bit 4: Input #2 — Tag Name: Device_Status: In_2 Bit 5: Motor Current — Tag Name: Device_Status: Motor_Current	Access Rule	Get
	Data Type	WORD
	Units	—
	Min. Value	0x0000
	Max. Value	0x003F
	Default Value	0x0000

## Advanced Setup Group

<b>Trip Enable</b>	<b>Parameter No.</b>	<b>12</b>
This parameter allows the installer to enable or disable the Jam Trip function  1 = Enabled 0 = Disabled  Bit 2: Jam— Tag Name: Trip_Enable: Jam	Access Rule	Get/Set
	Data Type	WORD
	Units	—
	Min. Value	0x0000
	Max. Value	0x0007
	Default Value	0x0000

<b>Warning Enable</b>	<b>Parameter No.</b>	<b>13</b>
This parameter allows the installer to enable or disable the warning functions separately. All warning functions are disabled from the factory.  1 = Enabled 0 = Disabled  Bit 0: Overload — Tag Name: Warning_Status: Overload Bit 2: Jam — Tag Name: Warning_Status: Jam Bit 3: Underload — Tag Name: Warning_Status: Underload Bit 5: Comm Fault — Tag Name: Warning_Status: Comm_Fault Bit 6: Comm Idle — Tag Name: Warning_Status: Comm_Idle	Access Rule	Get/Set
	Data Type	WORD
	Units	—
	Min. Value	0x0000
	Max. Value	0x007F
	Default Value	0x0000

<b>Single/Three Ph</b>	<b>Parameter No.</b>	<b>15</b>
This parameter configures the EtherNet/IP Module for single- or three-phase application. This parameter should be set to "Single Phase" when Bulletin 193S or 592S devices are employed.  0 = Single Phase 1 = Three Phase	Access Rule	Get/Set
	Data Type	BOOL
	Units	—
	Min. Value	0
	Max. Value	1
	Default Value	1
	Tag Name	Single_Three_Ph

<b>OL Reset Mode</b>	<b>Parameter No.</b>	<b>16</b>
This parameter defines whether a trip can be automatically or manually reset. This setting overrides the E1 Plus DIP switch adjustment while the SMM is powered. Note, however, that the E1 Plus manual reset button, accessible at the front, is always active.  0 = Manual 1 = Automatic	Access Rule	Get/Set
	Data Type	BOOL
	Units	—
	Min. Value	0
	Max. Value	1
	Default Value	0
	Tag Name	OL_Reset_Mode



<b>OL Warning Level</b>	<b>Parameter No.</b>	<b>17</b>
This parameter sets the overload warning level.	Access Rule	Get/Set
	Data Type	USINT
	Units	% TCU
	Min. Value	0
	Max. Value	100
	Default Value	90
	Tag Name	OL_Warning_Level
<b>Jam Inhibit Time</b>	<b>Parameter No.</b>	<b>18</b>
This parameter defines the amount of time for which jam detection is inhibited during a motor starting sequence.	Access Rule	Get/Set
	Data Type	USINT
	Units	Seconds
	Min. Value	0
	Max. Value	250
	Default Value	10
	Tag Name	Jam_Inhibit_Time
<b>Jam Trip Delay</b>	<b>Parameter No.</b>	<b>19</b>
This parameter allows the installer to program a time duration for which a jam condition must exist at the programmed level prior to the device tripping.	Access Rule	Get/Set
	Data Type	USINT
	Units	Seconds
	Min. Value	5
	Max. Value	250
	Default Value	50
	Tag Name	Jam_Trip_Delay
<b>Jam Trip Level</b>	<b>Parameter No.</b>	<b>20</b>
This parameter sets the jam trip level.	Access Rule	Get/Set
	Data Type	UINT
	Units	% FLA
	Min. Value	150
	Max. Value	600
	Default Value	250
	Tag Name	Jam_Trip_Level

<b>Jam Warn Level</b>	<b>Parameter No.</b>	<b>21</b>
This parameter sets the jam warning level.	Access Rule	Get/Set
	Data Type	UINT
	Units	% FLA
	Min. Value	100
	Max. Value	600
	Default Value	150
	Tag Name	Jam_Warn_Level
<b>UL Inhibit Time</b>	<b>Parameter No.</b>	<b>22</b>
This parameter defines the amount of time for which underload detection is inhibited during a motor starting sequence.	Access Rule	Get/Set
	Data Type	USINT
	Units	Seconds
	Min. Value	0
	Max. Value	250
	Default Value	10
	Tag Name	UL_Inhibit_Time
<b>UL Warn Level</b>	<b>Parameter No.</b>	<b>23</b>
This parameter sets the underload warning level.	Access Rule	Get/Set
	Data Type	USINT
	Units	% FLA
	Min. Value	30
	Max. Value	100
	Default Value	70
	Tag Name	UL_Warn_Level

## Reset/Lock Group

<b>Trip Reset</b>	<b>Parameter No.</b>	<b>14</b>
<p>This parameter provides the user with the capability of resetting a trip over the EtherNet/IP network. After a trip is reset, the parameter automatically returns to a "Ready" state.</p> <p>0 = Ready 1 = Reset Trip</p> <p>Note: A transition from 0 to 1 is necessary to trigger a trip reset when mapped on the cyclic data.</p>	Access Rule	Get/Set
	Data Type	BOOL
	Units	—
	Min. Value	0
	Max. Value	1
	Default Value	0
	Tag Name	Trip_Reset

<b>Program Lock</b>	<b>Parameter No.</b>	<b>24</b>
<p>This parameter prohibits the device parameters from being altered when set to "Locked". It must be set to "Unlocked" to allow parameter modification.</p> <p>It doesn't affect parameters when they're accessed through the assembly object.</p> <p>0 = Unlocked 1 = Locked</p>	Access Rule	Get/Set
	Data Type	BOOL
	Units	—
	Min. Value	0
	Max. Value	1
	Default Value	0
	Tag Name	Program_Lock

<b>Set To Defaults</b>	<b>Parameter No.</b>	<b>25</b>
<p>This parameter allows the user to reset the parameter settings to the factory default values. After parameter values have been reset to the factory default settings, the parameter automatically returns to a "Ready" state.</p> <p>0 = Ready 1 = Reset Defaults</p> <p>Note: A transition from 0 to 1 is necessary to trigger a set to default when mapped on the cyclic data.</p>	Access Rule	Get/Set
	Data Type	BOOL
	Units	—
	Min. Value	0
	Max. Value	1
	Default Value	0
	Tag Name	Set_To_Default

## I/O Setup Group

<b>OutA Pr FltState</b>	<b>Parameter No.</b>	<b>34</b>
<p>This parameter, in conjunction with the Pr FltValue, defines how Output A will respond when a trip occurs. When set to "1", Output A will continue to operate as commanded via the network. When set to "0", Output A will open or close as determined by the setting of the Pr FltValue.</p> <p>0 = Go to FltValue 1 = Ignore Fault</p>	Access Rule	Get/Set
	Data Type	BOOL
	Units	—
	Min. Value	0
	Max. Value	1
	Default Value	0
	Tag Name	OutA_Pr_FLTState
<b>OutA Pr FltValue</b>	<b>Parameter No.</b>	<b>35</b>
<p>This parameter determines the state that Output A assumes when a trip occurs and the Pr FltState is set to "0".</p> <p>0 = Open 1 = Closed</p>	Access Rule	Get/Set
	Data Type	BOOL
	Units	—
	Min. Value	0
	Max. Value	1
	Default Value	0
	Tag Name	OutA_Pr_FLTValue
<b>OutA En FltState</b>	<b>Parameter No.</b>	<b>36</b>
<p>This parameter, in conjunction with the FltValue, defines how Output A will respond when a EtherNet/IP network fault occurs. When set to "1", Output A will hold the state prior to trip occurrence. When set to "0", Output A will open or close as determined by the setting of the FltValue.</p> <p>0 = Go to FltValue 1 = Hold Last State</p>	Access Rule	Get/Set
	Data Type	BOOL
	Units	—
	Min. Value	0
	Max. Value	1
	Default Value	0
	Tag Name	OutA_En_FLTState
<b>OutA En FltValue</b>	<b>Parameter No.</b>	<b>37</b>
<p>This parameter determines the state that Output A assumes when a EtherNet/IP network fault occurs and the FltState is set to "0".</p> <p>0 = Open 1 = Closed</p>	Access Rule	Get/Set
	Data Type	BOOL
	Units	—
	Min. Value	0
	Max. Value	1
	Default Value	0
	Tag Name	OutA_En_FLTValue

<b>OutA En IdlState</b>	<b>Parameter No.</b>	<b>38</b>
<p>This parameter, in conjunction with the IdlState, defines how Output A will respond when the EtherNet/IP network is idle (clear mode). When set to "1", Output A will hold the state prior to trip occurrence. When set to "0", Output A will open or close. The En Flt parameters supersede the En Idl parameters.</p> <p>0 = Go to IdlValue 1 = Hold Last State</p>	Access Rule	Get/Set
	Data Type	BOOL
	Units	—
	Min. Value	0
	Max. Value	1
	Default Value	0
	Tag Name	OutA_En_IdlState
<b>OutA En IdlValue</b>	<b>Parameter No.</b>	<b>39</b>
<p>This parameter determines the state that Output A assumes when the network is idle and instructed by the IdlState parameter.</p> <p>0 = Open 1 = Closed</p>	Access Rule	Get/Set
	Data Type	BOOL
	Units	—
	Min. Value	0
	Max. Value	1
	Default Value	0
	Tag Name	OutA_En_IdlValue
<b>IN1 Assignment</b>	<b>Parameter No.</b>	<b>40</b>
<p>This parameter allows the user to assign a specific function to the discrete IN1 input.</p> <p>0 = Normal 1 = Trip Reset 2 = OL Contact</p>	Access Rule	Get/Set
	Data Type	USINT
	Units	—
	Min. Value	0
	Max. Value	2
	Default Value	0
	Tag Name	IN1_Assignment
<b>IN2 Assignment</b>	<b>Parameter No.</b>	<b>41</b>
<p>This parameter allows the user to assign a specific function to the discrete IN2 input.</p> <p>0 = Normal 1 = Trip Reset 2 = OL Contact</p>	Access Rule	Get/Set
	Data Type	USINT
	Units	—
	Min. Value	0
	Max. Value	2
	Default Value	0
	Tag Name	IN2_Assignment

## Trip History Group

<b>Trip Log 0</b>	<b>Parameter No.</b>	<b>5</b>
This parameter records the latest trip.	Access Rule	Get
	Data Type	WORD
	Units	—
	Min. Value	0x0000
	Max. Value	0x0007
	Default Value	0x0000
	Tag Name	Trip_Log_0
<b>Trip Log 1</b>	<b>Parameter No.</b>	<b>6</b>
This parameter records the trip previous to Trip Log 0.	Access Rule	Get
	Data Type	WORD
	Units	—
	Min. Value	0x0000
	Max. Value	0x0007
	Default Value	0x0000
	Tag Name	Trip_Log_1
<b>Trip Log 2</b>	<b>Parameter No.</b>	<b>7</b>
This parameter records the trip previous to Trip Log 1.	Access Rule	Get
	Data Type	WORD
	Units	—
	Min. Value	0x0000
	Max. Value	0x0007
	Default Value	0x0000
	Tag Name	Trip_Log_2
<b>Trip Log 3</b>	<b>Parameter No.</b>	<b>8</b>
This parameter records the trip previous to Trip Log 2.	Access Rule	Get
	Data Type	WORD
	Units	—
	Min. Value	0x0000
	Max. Value	0x0007
	Default Value	0x0000
	Tag Name	Trip_Log_3

---

<b>Trip Log 4</b>	<b>Parameter No.</b>	<b>9</b>
This parameter records the trip previous to Trip Log 3.	Access Rule	Get
	Data Type	WORD
	Units	—
	Min. Value	0x0000
	Max. Value	0x0007
	Default Value	0x0000
	Tag Name	Trip_Log_4

---





---

## Troubleshooting

### Introduction

The purpose of this chapter is to assist in troubleshooting the E1 Plus EtherNet/IP module.

---

**ATTENTION**

Servicing energized industrial control equipment can be hazardous. Electrical shock, burns, or unintentional actuation of controlled industrial equipment may cause death or serious injury. For safety of maintenance personnel, as well as other who may be exposed to electrical hazards associated with the maintenance activities, follow the local safety-related work practices (for example, the NFPS 70W, Part II, *Electrical Safety for Employee Workplaces*, in the United States) when working on or near energized equipment. maintenance personnel must be trained in the safety practices, procedures, and requirements that pertain to their respective job assignments. Do not work alone on energized equipment.

---

**ATTENTION**

Do not attempt to defeat or override fault circuits. The cause of a fault indication must be determined and corrected before attempting operation. Failure to correct a control system or mechanical malfunction may result in personal injury and/or equipment damage due to uncontrolled machine system operation.

---

## EtherNet/IP Modes of Operation

The E1 Plus EtherNet/IP Module has four EtherNet/IP modes of operation: Power-Up Reset Mode, Run Mode, Recoverable Error Mode, and Unrecoverable Error Mode.

### Power-Up Reset Mode

During Power-Up Reset Mode, the following occurs:

1. The *MODULE STATUS* LED should flash green for approximately 1/4 second, then red for 1/4 second. The *MODULE STATUS* LED will then stay lit green and the *NETWORK STATUS* LED should flash green for approximately 1/4 second, then red for 1/4 second before turning off. The *NETWORK STATUS* LED and the *MODULE STATUS* LED will now return to their standard indication.

---

**IMPORTANT**

The E1 Plus EtherNet/IP Module protection functions are still operational even without an established network connection.

---

2. The E1 Plus EtherNet/IP Module performs a duplicate IP address check to verify another module is not assigned to the same IP address. If a duplicate IP address is detected on the network, the *NETWORK STATUS* LED turns solid red, the *MODULE STATUS* LED turns flashing red, and the E1 Plus EtherNet/IP Module enters the *Recoverable Error Mode*.

If the power-up or reset is successful, the overload relay will enter *Run Mode*.

### Run Mode

In *Run Mode*, the E1 Plus EtherNet/IP Module will operate as a slave device to a master device. The *NETWORK STATUS* LED will blink green if there are no network connections established with a network master. When one or more connections are in the “established” state, the *NETWORK STATUS* LED will turn solid green. When one or more connections are in the “timed-out” state, the *NETWORK STATUS* LED will blink red. In the *Run Mode*, the E1 Plus EtherNet/IP Module will:

- Accept messages from a master on the EtherNet/IP network.
- Send response messages, COS messages, or CYCLIC messages to a master.

If a communication error is detected, the E1 Plus EtherNet/IP Module will either enter the *Recoverable Error* or *Unrecoverable Error Mode*.

## Recoverable Error Mode

In *Recoverable Error Mode*, the E1 Plus EtherNet/IP Module's *MODULE STATUS* LED turns flashing red. The overload relays will respond to messages that are specified in offline node recovery message protocol.

Error Type	Description	LED State
Recoverable	Duplicate IP address detected	Flashing Red

## Unrecoverable Error Mode

In *Unrecoverable Error Mode*, the E1 Plus EtherNet/IP Module's *MODULE STATUS* LED turns solid red. The overload relay continues in this state as long as the device is powered.

Error Type	Description	LED State
Unrecoverable	Power-up initialization failure	Solid Red
	Fatal communication error	

## EtherNet/IP Troubleshooting Procedures

The following table identifies possible causes and corrective actions when troubleshooting EtherNet/IP-related failures using the *NETWORK STATUS* LED.

**Table 7.1 EtherNet/IP Troubleshooting Procedures**

Color	State	Possible Cause	Corrective Action
None		The E1 Plus EtherNet/IP Module is not receiving power at the EtherNet/IP connector.	Check EtherNet/IP power and cable connections and the power connection on the EtherNet/IP connector.
Green Red Off	Flashing (once)	Normal	The Network Status LED flashes green, red, and off once during a normal power-up sequence.
Green	Flashing	E1 Plus EtherNet/IP Module is online but with no connections established.	Check EtherNet/IP master and its scan list for correct scanner configuration.
Green	Solid	Normal operating state, and the E1 Plus EtherNet/IP Module is allocated to a master.	No action required.
Red	Flashing	One or more connections timed-out.	Reset EtherNet/IP master device.
Red	Solid	<ol style="list-style-type: none"> <li>1. Diagnostics test failed on power-up/reset. Internal fault exists.</li> <li>2. Duplicate EtherNet/IP module address exists (two EtherNet/IP modules cannot have the same address).</li> <li>3. A fatal communication error occurred.</li> </ol>	<ol style="list-style-type: none"> <li>1. Cycle power to the unit and network. If the fault still exists, replace unit.</li> <li>2. Change the IP address to a valid setting and reset the device.</li> <li>3. Check EtherNet/IP media for proper installation.</li> </ol>

## Input and Output Troubleshooting Procedures

**ATTENTION**



If the outputs are to be commanded via an explicit message, ensure that there can never be an established I/O connection that can actively control them, and that the explicit message connection has a non-zero expected packet rate (EPR) setting.

**Table 7.2 Input and Output Troubleshooting Procedures**

Failure Type	Failure Description	Corrective Action
Input 1, 2	Input 1 or 2 does not appear to recognize a contact closure	<ol style="list-style-type: none"> <li>1. Check the supply voltage on the power connector.</li> <li>2. If the applicable contact closed but the E1 Plus EtherNet/IP Module Input does not recognize the closure, check the continuity and wiring to the connected contact.</li> <li>3. Check the IN 1 and 2 status LEDs. If the appropriate LED does not illuminate, measure the voltage across and current through the applicable input. Verify they are within the ratings of the E1 Plus EtherNet/IP Module (See Appendix A).</li> <li>4. If the appropriate Input LED does illuminate, but the input status is not reported properly over the EtherNet/IP network, check the programmable controller ladder logic and I/O mapping.</li> </ol>
Input 1, 2	Trip reset operation	Check the programming of Parameter 40, <i>IN1 Assignment</i> or Parameter 41, <i>IN2 Assignment</i> .

**Table 7.2 Input and Output Troubleshooting Procedures (Continued)**

Failure Type	Failure Description	Corrective Action
OUT A	Output A does not appear to turn on (close) when commanded to do so.	<ol style="list-style-type: none"> <li>1. Check the supply voltage on the power connector.</li> <li>2. Check the OUTA status LED. If the appropriate LED does not illuminate, check the programmable controller ladder logic and I/O mapping.</li> <li>3. If the appropriate Output LED is illuminated, remove the control circuit power and check for continuity across the appropriate output terminals (13/14). If the continuity test indicates the output is open, replace the E1 Plus EtherNet/IP Module. Check the supply voltage against the ratings of the contactor and the relay output before installing a new unit.</li> <li>4. Remove control circuit power and check the control circuit fuse and the control wiring to the E1 Plus EtherNet/IP Module output terminals.</li> <li>5. Check the control circuit power supply. Verify the voltage is within the contactor and overload relay ratings.</li> <li>6. Check the <i>DEVICE STATUS</i> and <i>TRIP STATUS</i> parameters. If a Protection Fault exists, refer to the <i>TRIP STATUS</i> parameters. If a EtherNet/IP-related fault exists, refer to the <i>EtherNet/IP</i> troubleshooting procedure.</li> <li>7. Check the OUTA Pr FltState, Pr FltValue, En FltState, En FltValue, En IdleState, and En IdleValue programmable parameters. The Pr FltState and Pr FltValue parameter supersede the En Flt or En Idle parameters.</li> </ol>
OUT A	Output A does not appear to turn off (open) when commanded to do so.	<ol style="list-style-type: none"> <li>1. Check the OUTA status LED. If the appropriate LED remains illuminated, check the programmable controller ladder logic and I/O mapping.</li> <li>2. If the appropriate Output LED is not illuminated, remove the control circuit power and check for continuity across the appropriate output terminals (13/14). If the continuity test indicates the output is closed, replace the E1 Plus EtherNet/IP Module. Check the supply voltage against ratings of the contactor and the relay output before installing a new unit.</li> <li>3. Remove control circuit power and check the control circuit fuse and the control wiring to the E1 Plus EtherNet/IP Module output terminals.</li> <li>4. Check the OUTA Pr FltState, Pr FltValue, En FltState, En FltValue, En IdleState, and En IdleValue programmable parameters. Then check the <i>DEVICE STATUS</i> and <i>TRIP STATUS</i> parameters. If a Protection Fault exists, refer to the <i>TRIP STATUS</i> parameters. If a EtherNet/IP-related fault exists, refer to the <i>EtherNet</i> troubleshooting procedure.</li> </ol>
OUT A	The contactor connected to Output A appears to "chatter"	<ol style="list-style-type: none"> <li>1. Verify the OUT A LED remains in the appropriate On or Off state. If the LED is flickering, check the programmable controller's ladder logic program.</li> <li>2. Check the control circuit supply voltage. Verify it is within the ratings of the contactor coil and the overload relay's outputs.</li> <li>3. Remove the control circuit power. Verify all control wiring is properly secured.</li> </ol>

## Specifications

<b>Terminal Ratings:</b>		
Terminal Screw		M3
Wire Cross Section		See wiring diagram section
Torque		0.56...0.79 N•m (5...7 lb.-in)
Degree of Protection		IP20
<b>Power Supply Ratings:</b>		
Rated Supply Voltage	$U_s$	24V DC
Rated Operating Range	$U_e$	24V -15%, +10% DC
Rated Supply Current	$I_e$	110 mA at 24V DC
Maximum Surge Current at Power-Up		2.5 A
Maximum Power Consumption		2.7 W
<b>Output Relay Ratings:</b>		
Terminals OUT A:		13/14
Type of Contacts		Form A SPST - NO
Rated Thermal Current	$I_{the}$	5 A
Rated Insulation Voltage	$U_i$	300V AC
Rated Operating Voltage	$U_e$	240V AC
Rated Operating Current	$I_e$	3 A (at 120V AC), 1.5 A (at 240V AC) 0.25 A (at 110V DC), 0.1 A (at 220V DC)
Minimum Operating Current		10 mA at 5V DC
Rating Designation		B300
Utilization Category		AC-15
Resistive Load Rating (p.f.=1.0)		5 A, 250V DC 5 A, 30V DC
Inductive Load Rating (p.f.=0.4), (L/R=7 ms)		2 A, 250V AC 2 A, 30V DC
Short Circuit Current Rating		1,000 A
Recommended Control Circuit Fuse		KTK-R-6 (6 A, 600V)

Rated Number of Operations Out A: W/100-C-09...100-C43 W/100-C-60...100-C85 W/NEMA Size 0...2 W/NEMA Size 3	5,000,000 2,500,000 1,000,000 300,000
<b>Input Ratings:</b>	
Terminals IN 1: IN 2: SSV (Sensor Supply Voltage)	1 2 3
Supply Voltage (provided by module)	24V DC±10%
Type of Inputs	Current Sinking
ON-State Voltage	15V DC
On-State Current (turn-on)	2 mA
Steady State Current	5 mA
Off-State Voltage	5V DC
Off-State Current	0.5 mA
Transition Voltage	5...15V DC
Transition Current	0.5...2.0 mA
<b>Environmental Ratings:</b>	
Ambient Temperature <i>Tamb</i> Storage Operating (Open) (Enclosed)	-40...+85°C (-40...+185°F) -20...+60°C (-4...+140°F) -20...+40°C (-4...+104°F)
Humidity Operating Damp Heat - Steady State Damp Heat - Cyclic	5...95% non-condensing per IEC 68-2-3 per IEC 68-2-30
Cooling Method	Natural Convection
Vibration (per IEC 68-2-6)	3 G
Shock (per IEC 68-2-27)	30 G
Maximum Altitude	2000 m
Pollution Environment	Pollution Degree 2
Terminal Marking	EN 50012
Degree of Protection	IP20
<b>Electromagnetic Compatibility</b>	
Electrostatic Discharge Immunity Test Level  Performance Criteria	8 kV Air Discharge 4 kV Contact Discharge 1 <sup>(1)</sup> (2)



RF Immunity Test Level	10V/m
Performance Criteria	1(1)(2)
Electrical Fast Transient/Burst Immunity Test Level	2 kV (Power) 1 kV (control)
Performance Criteria	1(1)(2)
Surge Immunity Test Level	2 kV L-E 1 kV L-L
Performance Criteria	1(1)(2)
Radiated Emissions	Class A
Conducted Emissions	Not tested

(1) Performance Criteria 1 requires the DUT (device under test) not to experience degradation or loss of performance.

(2) Environment 2 - Heavy Industrial.

**WARNING**

This is a class A product. In domestic environment, this product may cause radio interference, in which case the user may be required to take adequate measures.

**EtherNet/IP Communications:**

Connections TCP CIP	150 48
CIP Unconnected Messages	128
Packet Rates (packets/second) I/O HIM/MSG	500 500
Media Support Twisted Pair Fiber	Yes No
Speed Duplex (Half/Full)	10/100
Duplicate IP Detection	Yes

**Jam Protection:**

Trip Level	150...600% FLA
Trip Delay	0.1...25.0 sec.
Inhibit	0...250 sec.

**Standards and Certifications**

UL 508

CSA 22.2, No. 14

EN 60947-4-1



## EtherNet/IP Information

### Electronic Data Sheets

Electronic Data Sheet (EDS) files are specially formatted ASCII files that provide all of the information necessary for a configuration tool (e.g., RSNetWorx for EtherNet/IP) to access and alter the parameters of a device. The EDS file contains all the parameter information of a device: number of parameters, groupings, parameter name, min, max, and default values, units, data format and scaling. The EDS file for the E1 Plus EtherNet/IP Module is available from the Internet at [www.ab.com/networks/eds/index/html](http://www.ab.com/networks/eds/index/html). It can also be built automatically by some configuration tools since all of the information necessary for an EDS file may be extracted from the E1 Plus EtherNet/IP Module.

### EtherNet/IP Objects

The following object classes are supported.

**Table B.1 EtherNet object Classes**

<b>Class</b>	<b>Object</b>
0x01	Identity
0x02	Message Router
0x04	Assembly
0x06	Connection Manager
0x08	Discrete Input Point
0x09	Discrete Output Point
0x0F	Parameter
0x10	Parameter Group
0x29	Control Supervisor
0x2C	Overload
0xC2	PCP
0xF5	TCP/IP Interface
0xF6	Ethernet Link

## Identity Object — CLASS CODE 0x01

The following class attributes are supported for the Identity Object:

**Table B.2 Identity Object Class Attributes**

Attribute ID	Access Rule	Name	Data Type	Value
1	Get	Revision	UINT	0x0001

Identity Object instances contain the following instance attributes:

**Table B.3 Identity Object Instance Attributes**

Attribute ID	Access Rule	Name	Data Type	Value
1	Get	Vendor ID	UINT	Programmable via test object
2	Get	Device Type	UINT	0x0003
3	Get	Product Code	UINT	300
4	Get	Revision	Structure of:	
		Major Revision	USINT	1
		Minor Revision	USINT	N/A
5	Get	Status	WORD	Bit 0: Owned, shall be set when at least one connection is configured Bit 1: Reserved, set to 0 Bit 2: Configured Bit 3: Reserved, set to 0 Bit 4-7: See extended device status Bit 8: Minor Recoverable fault Bit 9: Minor Unrecoverable fault Bit 10: Major Recoverable fault Bit 11: Major Unrecoverable fault Bit 12-15: Reserved, set to 0  Extended device status (Bit 4-7) 0000=Unknown 0001=Firmware updated in progress 0010=Faulted I/O connection 0011=No I/O connection established 0100=Non volatile configuration bad 0101=Major fault 0110=Connection in run mode 0111=Connection in idle mode
6	Get	Serial Number	UDINT	Unique number assigned for each device
7	Get	Product Name	SHORT_STRING	Product name
8	Get	State	USINT	3=Operational

The following common services are implemented for the Identity Object:

**Table B.4 Identity Object Common Services**

Service Code	Implemented for:		Service Name
	Class	Instance	
0x01	No	Yes	Get Attribute All
0x0E	Yes	Yes	Get Attribute Single
0x05	No	Yes	Reset

## Message Router Object — CLASS CODE 0x02

No class or instance attributes are supported. The message router object exists only to rout explicit messages to other objects.

## Assembly Object — CLASS CODE 0x04

The following class attributes are supported for the Assembly Object:

**Table B.5 Assembly Object Class Attributes**

Attribute ID	Access Rule	Name	Data Type	Value
1	Get	Revision	UINT	0x0002
2	Get	Max Instance	UINT	120

### *Instance Attributes*

Instances/Connection points implements the following data attributes:

**Table B.6 Instance Attributes**

#	Access	Name	Type	Value	Description
1	Get	Number of members in list	UINT	N/A	No. of members to follow in the list in attribute #2
2	Get	Member list	Array of	N/A	Array of CIP paths
3	Get/Set	Data	Array of UINT	—	Data produced/consumed by the module
4	Get	Size	UINT	N/A	No. of USINTs in attribute #3
100	Get	Name	SHORT_STRING	N/A	Name of the assembly instance

*Output Assemblies*

The following output assembly instances are implemented:

**Table B.7 Instance 2 — Basic Overload Output Assembly from ODVA Profile**

Byte	Bit 7	Bit 6	Bit 5	Bit 4	Bit 3	Bit 2	Bit 1	Bit 0
0						Trip Reset		

**Table B.8 Instance 101 — Similar to Basic Contact Output Assembly from ODVA Contact Profile**

Byte	Bit 7	Bit 6	Bit 5	Bit 4	Bit 3	Bit 2	Bit 1	Bit 0
0								Output A

**Table B.9 Instance 103 — Similar to Basic Starter Output Assembly from ODVA Starter Profile**

Byte	Bit 7	Bit 6	Bit 5	Bit 4	Bit 3	Bit 2	Bit 1	Bit 0
0						Trip Reset		Output A

*Input Assemblies*

**Table B.10 Instance 50 — Trip Status Input Assembly from ODVA Overload Profile**

Byte	Bit 7	Bit 6	Bit 5	Bit 4	Bit 3	Bit 2	Bit 1	Bit 0
0								Tripped

**Table B.11 Instance 51 — Basic Status Input Assembly from ODVA Overload Profile**

Byte	Bit 7	Bit 6	Bit 5	Bit 4	Bit 3	Bit 2	Bit 1	Bit 0
0							Warning	Tripped

**Table B.12 Instance 106 — Motor Starter Input Assembly**

Byte	Bit 7	Bit 6	Bit 5	Bit 4	Bit 3	Bit 2	Bit 1	Bit 0
0	Motor Current		Input 2	Input 1		Out A Stat	Warning	Tripped

**Table B.13 Instance 110 — Extended Motor Starter Input Assembly**

Byte	Bit 7	Bit 6	Bit 5	Bit 4	Bit 3	Bit 2	Bit 1	Bit 0
0	Motor Current		Input 2	Input 1		Out A Stat	Warning	Tripped
1	Unused							
2	Average %FLA (low byte)							
3	Average %FLA (high byte)							
4	%Therm Utilized (low byte)							
5	%Therm Utilized (high byte)							

**Table B.14 Instance 111 — Complete Motor Starter Input Assembly**

Byte	Bit 7	Bit 6	Bit 5	Bit 4	Bit 3	Bit 2	Bit 1	Bit 0
0	Motor Current		Input 2	Input 1		Out A Stat	Warning	Tripped
1	Unused							
2	Average %FLA (low byte)							
3	Average %FLA (high byte)							
4	%Therm Utilized (low byte)							
5	%Therm Utilized (high byte)							
6	Trip Status (low byte)							
7	Trip Status (high byte)							
8	Warning Staus (low byte)							
9	Warning Status (high byte)							
10	Device Status (low byte)							
11	Device Status (high byte)							
12	Trip Log 0 (low byte)							
13	Trip Log 0 (high byte)							
14	Trip Log 1 (low byte)							
15	Trip Log 1 (high byte)							
16	Trip Log 2 (low byte)							
17	Trip Log 2 (high byte)							
18	Trip Log 3 (low byte)							
19	Trip Log 3 (high byte)							
20	Trip Log 4 (low byte)							
21	Trip Log 4 (high byte)							

The following services are implemented for the Assembly Object:

**Table B.15 EtherNet Object Common Services**

Service Code	Implemented for:			Service Name
	Class	Instance Consuming	Instance Producing	
0x0E	Yes	Yes	Yes	Get Attribute Single
0x10	No	Yes	No	Set Attribute Single

## Connection Manager Object — CLASS CODE 0x06

No class or instance attributes are supported.

The following common services are implemented for the Connection Manager Object:

**Table B.16 Connection Manager Object Common Services**

Service Code	Implemented for:		Service Name
	Class	Instance	
0x54	No	Yes	Forward Open
0x4E	No	Yes	Forward Close

## Discrete Input Point Object — CLASS CODE 0x08

The following class attributes are supported for the Discrete Input Point Object:

**Table B.17 Discrete Input Point Object Class Attributes**

Attribute ID	Access Rule	Name	Data Type	Value
1	Get	Revision	UINT	0x0002
2	Get	Max Instance	UINT	0x0002

Two instances of the Discrete Input Point Object are supported as follows:

**Table B.18 Discrete Input Point Object Instances**

Attribute ID	Access Rule	Name	Data Type	Value
3	Get	Value	BOOL	0=OFF 1=ON

The following common services are implemented for the Discrete Input Point Object:

**Table B.19 Discrete Input Object Common Services**

Service Code	Implemented for:		Service Name
	Class	Instance	
0x0E	Yes	Yes	Get Attribute Single



## Discrete Output Point Object — CLASS CODE 0x09

The following class attributes are supported for the Discrete Output point Object:

**Table B.20 Discrete Output Point Object Class Attributes**

Attribute ID	Access Rule	Name	Data Type	Value
1	Get	Revision	UINT	0x0001
2	Get	Max Instance	UINT	0x0001

A single instance is implemented and contains the following attributes:

**Table B.21 Discrete Output Point Object Instance 1 - Output A**

Attribute ID	Access Rule	Name	Data Type	Value
3	Get	Value	BOOL	0=OFF 1=ON
5	Get/Set	Fault Action	BOOL	0=Fault Value Attribute 1=Hold Last State
6	Get/Set	Fault Value	BOOL	0=OFF 1=ON
7	Get/Set	Idle Action	BOOL	0=Fault Value Attribute 1=Hold Last State
8	Get/Set	Idle Value	BOOL	0=OFF 1=ON
113	Get/Set	Pr Fault Action	BOOL	0=Pr Fault Value Attribute 1=Ignore
114	Get/Set	Pr Fault Value	BOOL	0=OFF 1=ON

The following common services are implemented for the Discrete Output Point Object:

**Table B.22 Discrete Output Object Common Services**

Service Code	Implemented for:		Service Name
	Class	Instance	
0x0E	Yes	Yes	Get Attribute Single
0x10	No	Yes	Set Attribute Single

## Parameter Object — CLASS CODE 0x0F

The following class attributes are supported for the Parameter Object:

**Table B.23 Parameter Object Class Attributes**

Attribute ID	Access Rule	Name	Data Type	Value
1	Get	Revision	UINT	0x0001
2	Get	Max Instance	UINT	0x0029
8	Get	Parameter Class Descriptor	WORD	0x000B
9	Get	Configuration Assembly Instance	UINT	0x0078
10	Get	Native Language	UINT	0x01=English

The following instance attributes are implemented for all parameter attributes:

**Table B.24 Parameter Object Instance Attributes**

Attribute ID	Access Rule	Name	Data Type	Value
1	Get/Set	Value	Specified in Descriptor	N/A
2	Get	Link Path Size	USINT	N/A
3	Get	Link Path	Packed EPATH:	Path to specified object attribute
4	Get	Descriptor	WORD	Parameter Dependent
5	Get	Data Type	EPATH	Parameter Dependent
6	Get	Data Size	USINT	Parameter Dependent
7	Get	Parameter Name String	SHORT_STRING	Parameter Dependent
8	Get	Units String	SHORT_STRING	Parameter Dependent
9	Get	Help String	SHORT_STRING	Parameter Dependent
10	Get	Minimum Value	Specified in Descriptor	Parameter Dependent
11	Get	Maximum Value	Specified in Descriptor	Parameter Dependent
12	Get	Default Value	Specified in Descriptor	Parameter Dependent
13	Get	Scaling Multiplier	UINT	1
14	Get	Scaling Divisor	UINT	1
15	Get	Scaling Base	UINT	1
16	Get	Scaling Offset	INT	0
17	Get	Multiplier Link	UINT	0
18	Get	Divisor Link	UINT	0
19	Get	Base Link	UINT	0
20	Get	Offset Link	UINT	0
21	Get	Decimal Precision	USINT	Parameter Dependent

The following common services are implemented for the Parameter Object:

**Table B.25 Parameter Object Common Services**

Service Code	Implemented for:		Service Name
	Class	Instance	
0x01	No	Yes	Get Attribute All
0x0E	Yes	Yes	Get Attribute Single
0x10	No	Yes	Set Attribute Single
0x4B	No	Yes	Get Enum String

## Parameter Group Object — CLASS CODE 0x10

The following class attributes are supported for the Parameter Group Object:

**Table B.26 Parameter Group Object Class Attributes**

Attribute ID	Access Rule	Name	Data Type	Value
1	Get	Revision	UINT	0x0001
2	Get	Max Instance	UINT	0x0005
8	Get	Native Language	USINT	0x01=English

The following parameter group objects are supported:

- Instance 1 = Monitor Parameters
- Instance 2 = Trip History
- 
- Instance 3 = Reset/Lock
- Instance 4 = Advanced Setup
- Instance 5 = I/O Setup

The following instance attributes are supported for all parameter group instances:

**Table B.27 Parameter Group Object Instance Attributes**

Attribute ID	Access Rule	Name	Data Type	Value
1	Get	Group Name String	SHORT_STRING	N/A
2	Get	Number of Members	UINT	N/A
3	Get	1st Parameter	UINT	N/A
4	Get	2nd parameter	UINT	N/A
n	Get	Nth Parameter	UINT	N/A

The following common services are implemented for the Parameter Group Object:

**Table B.28 Parameter Group Object Common Services**

Service Code	Implemented for:		Service Name
	Class	Instance	
0x0E	Yes	Yes	Get Attribute Single

### Control Supervisor Object — CLASS CODE 0x29

No class attributes are supported for the Control Supervisor Object. A single instance (instance 1) of the Control Supervisor Object is supported. The following instance attributes are supported.

**Table B.29 Control Supervisor Object Instance 1 Attributes**

Attribute ID	Access Rule	Name	Data Type	Value
10	Get	Faulted	BOOL	0=No Fault present 1= Fault Latched
11	Get	Warning	BOOL	0=No Warnings present 1=Warning present (not latched)
12	Get/Set	Fault Rst	BOOL	0=No action 0->1=Fault reset
13	Get	FaultCode	UINT	If in Faulted state, FaultCode indicates the fault that caused the transition to Faulted state. If not in Faulted state, FaultCode indicates the fault that caused the last transition to the Faulted state.
14	Get	Warning Code	UINT	Code word indicating warning present. If multiple warnings are present, the lowest code value is displayed.
100	Get	Trip Status	WORD	Bit 0=Overload Bit 1=Phase Loss Bit 2=Jam Bit 3-Bit 15=Not used
101	Get	Warning Status	WORD	Bit 0=Overload Bit 1=Not Used Bit 2=Jam Bit 3=Underload Bit 4=Not Used Bit 5=Comm Fault Bit 6=Comm Idle Bit 7=Non Vol Mem Fault Bit 8-Bit 15=Not used
102	Get	Trip Log 0	WORD	Last trip condition. Bit definitions of the value are the same as attribute 110.
103	Get	Trip Log 1	WORD	Last trip condition. Bit definitions of the value are the same as attribute 110.

**Table B.29 Control Supervisor Object Instance 1 Attributes**

Attribute ID	Access Rule	Name	Data Type	Value
104	Get	Trip Log 2	WORD	Last trip condition. Bit definitions of the value are the same as attribute 110.
105	Get	Trip Log 3	WORD	Last trip condition. Bit definitions of the value are the same as attribute 110.
106	Get	Trip Log 4	WORD	Last trip condition. Bit definitions of the value are the same as attribute 110.
107	Get	Device Status	WORD	Bit 0=Trip Bit 1=Warning Bit 2=OutputA Bit 3=Input 1 Bit 4=Input 2 Bit 5=Motor Current Bit 6=Bit 15=Not used
108	Get/Set	Trip Enable	WORD	Bit 0=Not Used Bit 1=Not Used Bit 2=Jam Bit 3=Bit 15=Not Used
109	Get/Set	Warning Enable	WORD	Bit 0=Overload Bit 1=Not Used Bit 2=Jam Bit 3=Underload Bit 4=Not Used Bit 5=Comm Fault Bit 6=Comm Idle Bit 7=Bit 15=Not Used
110	Get/Set	OL Reset Mode	BOOL	0=Manual 1=Automatic
111	Get/Set	IN1 Assignment	USINT	0=Normal 1=Trip Reset 2=OL Contact
112	Get/Set	IN2 Assignment	USINT	0=Normal 1=Trip Reset 2=OL Contact

The following common services are implemented for the Control Supervisor Object:

**Table B.30 Control Supervisor Object Common Services**

Service Code	Implemented for:		Service Name
	Class	Instance	
0x0E	No	Yes	Get Attribute Single
0x10	No	Yes	Set Attribute Single
0x05	No	Yes	Reset

## Overload Object — CLASS CODE 0x2C

No class attributes are supported for the Overload Object. A single instance (instance 1) of the Overload Object is supported:

**Table B.31 Overload Object Instance Attributes**

Attribute ID	Access Rule	Name	Data Type	Value
7	Get	% Thermal Utilized	USINT	xxx% FLA
108	Get	Average %FLA	UINT	0-1000 %FLA
109	Get	% Thermal Utilized	USINT	0-100%
127	Get/Set	Single/Three Phase	BOOL	0=Single Phase 1=Three Phase
132	Get/Set	OL Warn Level	USINT	0-100% TCU
141	Get/Set	Jam Inhibit Time	USINT	0-250 Sec.
142	Get/Set	Jam Trip Delay	USINT	0.5-25.0 Sec.
143	Get/Set	Jam Trip Level	UINT	150-600 %FLA
144	Get/Set	Jam Warn Level	UINT	100-600 %FLA
145	Get/Set	UL Inhibit Time	USINT	0-250 Sec.
148	Get/Set	UL Warn Level	USINT	30-100 %FLA

The following common services are implemented for the Overload Object:

**Table B.32 Overload Object Common Services**

Service Code	Implemented for:		Service Name
	Class	Instance	
0x0E	No	Yes	Get Attribute Single
0x10	No	Yes	Set Attribute Single

## PCP Object — CLASS CODE 0xC2

The following class attributes are supported for the PCP Object:

**Table B.33 PCP Object Class Attributes**

Attribute ID	Access Rule	Name	Data Type	Value
1	Get	Revision	UINT	1

The following instance attributes are implemented for all parameter attributes:

**Table B.34 PCP Object Instance Attributes**

Attribute ID	Access Rule	Name	Data Type	Value
1	Get/Set	MCC Number	USINT	0-255
2	Get/Set	Vertical Section Number	USINT	0-255
3	Get/Set	Starting Section Letter	USINT	0-255
4	Get/Set	Space Factors	USINT	0-0x3F
5	Get/Set	Cabinet Width	USINT	0-255
6	Get/Set	Controlled Device	USINT	0-255
7	Get	Number of Device Inputs	USINT	2
8	Get/Set	Devices Connected at Inputs	Array of USINT	
9	Get	Number of Device Outputs	USINT	1
10	Get/Set	Devices Connected at Outputs	Array of USINT	

The following common services are implemented for the PCP Object:

**Table B.35 PCP Object Common Services**

Service Code	Implemented for:		Service Name
	Class	Instance	
0x01	No	Yes	Get Attribute All
0x02	No	Yes	Set Attribute All
0x0E	Yes	Yes	Get Attribute Single
0x10	No	Yes	Set Attribute Single

## TCP/IP Interface Object — CLASS CODE 0xF5

The following class attributes are supported for the TCP/IP Interface Object:

**Table B.36 TCP/IP Interface Object Class Attributes**

Attribute ID	Access Rule	Name	Data Type	Value
1	Get	Revision	UINT	1

The following instance attributes are implemented for all parameter attributes:

**Table B.37 TCP/IP Interface Object Instance Attributes**

Attribute ID	Access Rule	Name	Data Type	Value
1	Get	Status	DWORD	N/A
2	Get	Configuration capability	DWORD	0x00000014
3	Get/Set	Configuration control	DWORD	N/A
4	Get	Physical Link Object	Struct of:	
		Path size	UINT	0x0002
		Path	Padded EPATH	20 F6 24 01
5	Get/Set	Interface configuration	Structure of:	
		IP Address	UDINT	
		Network Mask	UDINT	
		Gateway Address	UDINT	
		Name Server	UDINT	
		Name Server 2	UDINT	
		Domain Name	STRING	
6	Get/Set	Host Name	STRING	
8	Get/Set	TTL Value	USINT	1
9	Get/Set	Mcast Config	Structure of:	
		Alloc Control	USINT	0
		Reserverd	USINT	
		Num Mcast	UINT	4
		Mcast Start Addr	UDINT	



The following common services are implemented for the TCP/IP Interface Object:

**Table B.38 TCP/IP Interface Common Services**

Service Code	Implemented for:		Service Name
	Class	Instance	
0x01	No	Yes	Get Attribute All
0x0E	Yes	Yes	Get Attribute Single
0x10	No	Yes	Set Attribute Single

### Ethernet Link Object — CLASS CODE 0xF6

The following class attributes are supported for the Ethernet Link Object:

**Table B.39 Ethernet Link Object Class Attributes**

Attribute ID	Access Rule	Name	Data Type	Value
1	Get	Revision	UINT	3

The following instance attributes are implemented for all parameter attributes:

**Table B.40 Ethernet Link Object Instance Attributes**

Attribute ID	Access Rule	Name	Data Type	Value
1	Get	Interface Speed	UDINT	10 or 100
2	Get	Interface Flags	DWORD	
3	Get	Physical Address	ARRAY of 6 USINTs	MAC Address
4	Get	Interface Counterse	Structure of:	
		In Octets	UDINT	N/A
		In Ucast Packets	UDINT	N/A
		In NUcast Packets	UDINT	N/A
		In Discards	UDINT	N/A
		In Errors	UDINT	N/A
		In Unknown Protos	UDINT	N/A
		Out Octets	UDINT	N/A
		Out Ucast Packets	UDINT	N/A
		Out NUcast Packets	UDINT	N/A
		Out Discards	UDINT	N/A
Out Errors	UDINT	N/A		

**Table B.40 Ethernet Link Object Instance Attributes**

Attribute ID	Access Rule	Name	Data Type	Value
5	Get	Media Counters	Structure of:	
		Alignment Errors	UDINT	N/A
		FCS Errors	UDINT	N/A
		Single Collisions	UDINT	N/A
		Multiple Collisions	UDINT	N/A
		SQE Test Errors	UDINT	0
		Deferred Transmission	UDINT	N/A
		Late Collisions	UDINT	N/A
		Excessive Collisions	UDINT	N/A
		MAC Transmit Errors	UDINT	N/A
		Carrier Sense Errors	UDINT	N/A
		Frame Too Long	UDINT	N/A
		MAC Receive Errors	UDINT	N/A
6	Get/Set	Interface Control	Structure of:	
		Control Bits	WORD	N/A
		Forces Interface Speed	UINT	N/A

The following common services are implemented for the Ethernet Link Object:

**Table B.41 Ethernet Link Common Services**

Service Code	Implemented for:		Service Name
	Class	Instance	
0x01	Yes	Yes	Get Attribute All
0x0E	No	Yes	Get Attribute Single
0x10	No	Yes	Set Attribute Single
0x4C	No	Yes	Get And Clear

## Rockwell Automation Support

Rockwell Automation provides technical information on the web to assist you in using its products. At <http://support.rockwellautomation.com>, you can find technical manuals, a knowledge base of FAQs, technical and application notes, sample code and links to software service packs, and a MySupport feature that you can customize to make the best use of these tools.

For an additional level of technical phone support for installation, configuration and troubleshooting, we offer TechConnect Support programs. For more information, contact your local distributor or Rockwell Automation representative, or visit <http://support.rockwellautomation.com>.

### Installation Assistance

If you experience a problem with a hardware module within the first 24 hours of installation, please review the information that's contained in this manual. You can also contact a special Customer Support number for initial help in getting your module up and running:

United States	1.440.646.3223 Monday – Friday, 8am – 5pm EST
Outside United States	Please contact your local Rockwell Automation representative for any technical support issues.

### New Product Satisfaction Return

Rockwell tests all of its products to ensure that they are fully operational when shipped from the manufacturing facility. However, if your product is not functioning and needs to be returned:

United States	Contact your distributor. You must provide a Customer Support case number (see phone number above to obtain one) to your distributor in order to complete the return process.
Outside United States	Please contact your local Rockwell Automation representative for return procedure.





Rockwell Automation, Allen-Bradley, RSLinx, ControlLogix, CompactLogix, SoftLogix, SLC-5/05, RSLogix 5000, and SMM are trademarks of Rockwell Automation, Inc.

**[www.rockwellautomation.com](http://www.rockwellautomation.com)**

---

**Power, Control and Information Solutions Headquarters**

Americas: Rockwell Automation, 1201 South Second Street, Milwaukee, WI 53204 USA, Tel: (1) 414.382.2000, Fax: (1) 414.382.4444

Europe/Middle East/Africa: Rockwell Automation, Vorstlaan/Boulevard du Souverain 36, 1170 Brussels, Belgium, Tel: (32) 2 663 0600, Fax: (32) 2 663 0640

Asia Pacific: Rockwell Automation, Level 14, Core F, Cyberport 3, 100 Cyberport Road, Hong Kong, Tel: (852) 2887 4788, Fax: (852) 2508 1846