

CRITICAL TO QUALITY CLASSIFICATION TABLE				
	P=PERFORMANCE, F=FIT, A=ASSEMBLY			
	X=IDENTIFIES APPLICABLE CLASSIFICATION(S)			
	◇=ENGINEERING AND/OR MANUFACTURING REQUIREMENT			
	⊙=REGULATORY REQUIREMENT-CONFORMANCE IS MANDATORY			
COMMENTS	DRAWING ZONE	◇	◇	◇
ROHS	G1-H1			X

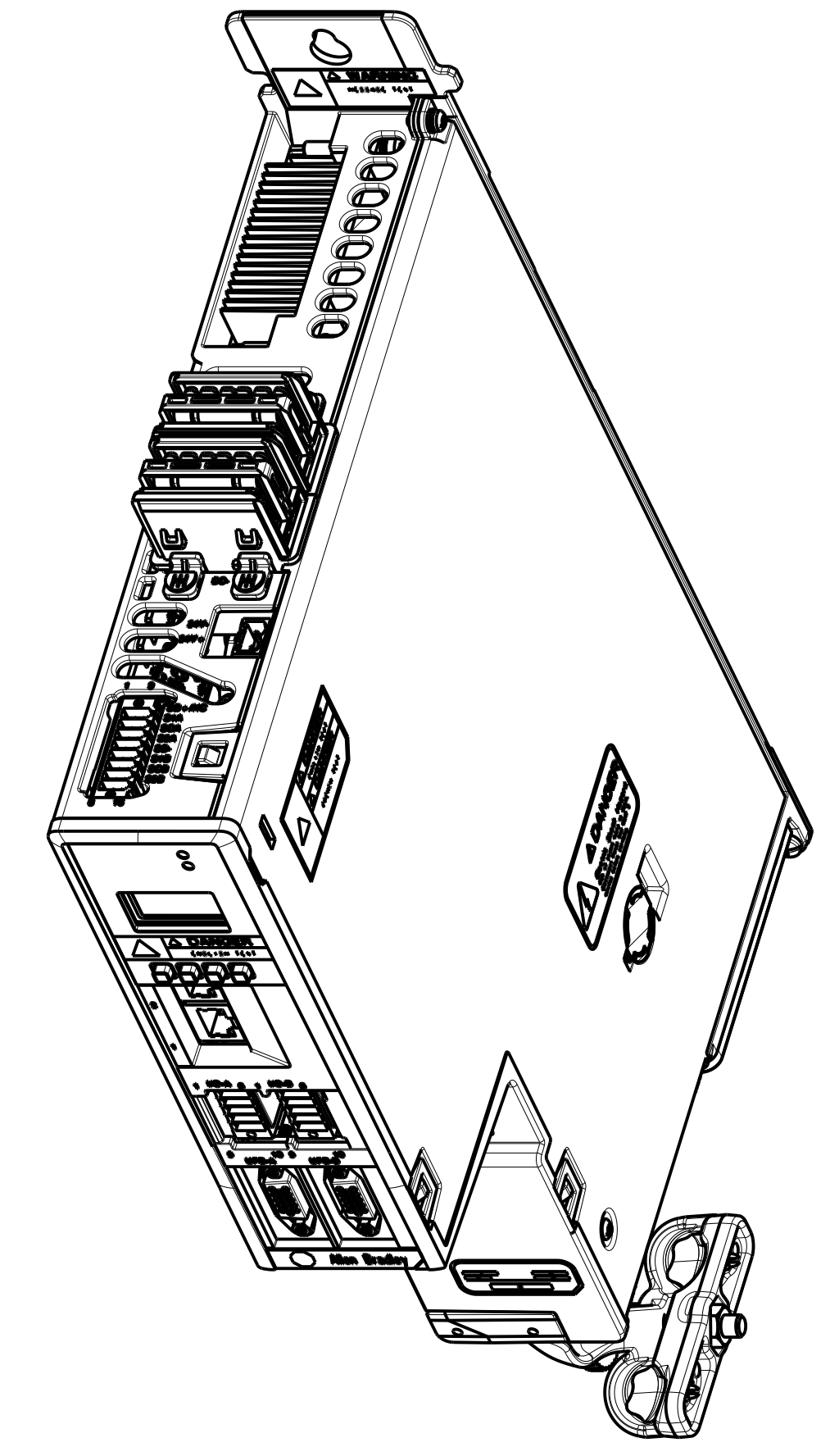
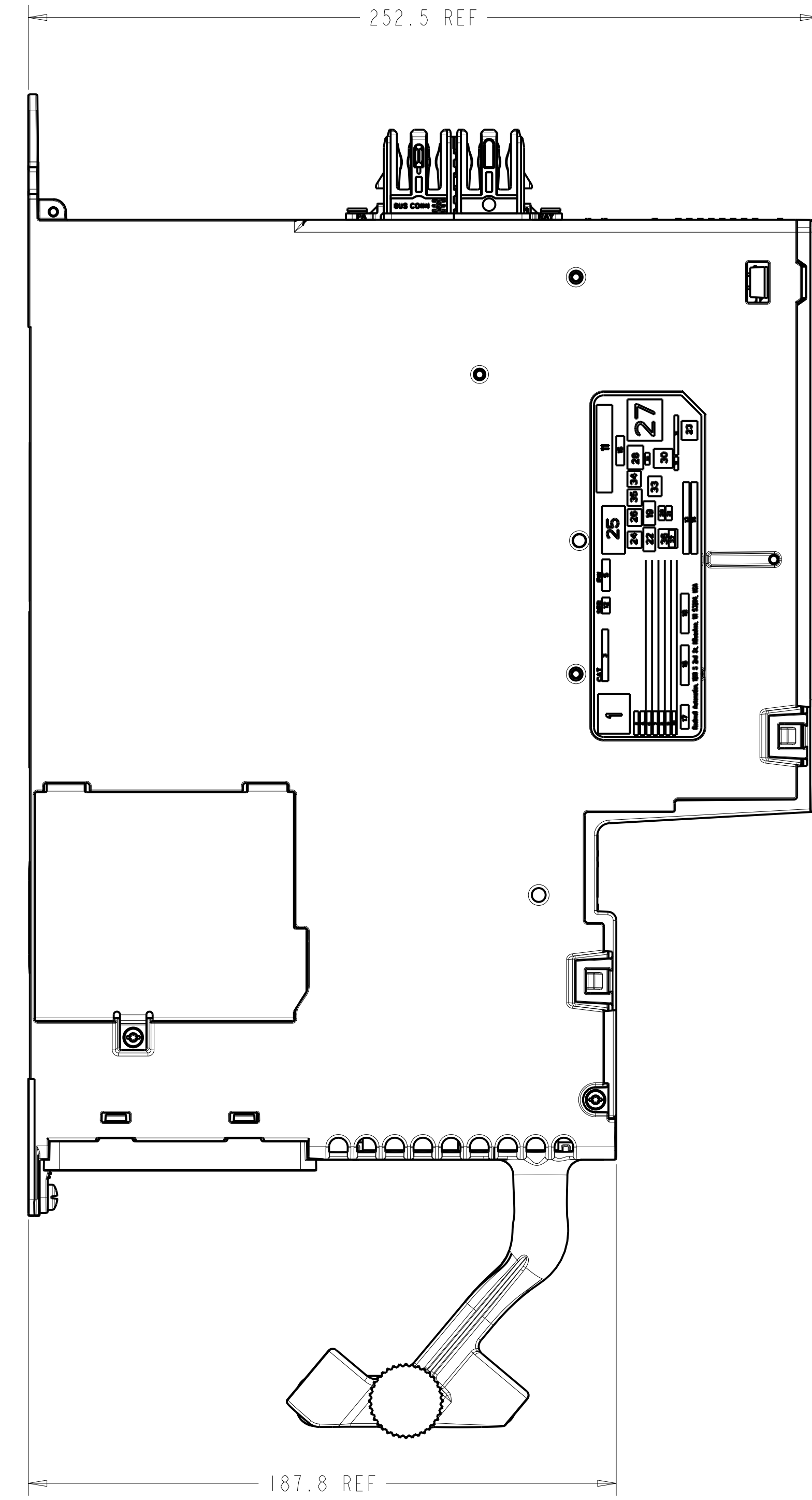
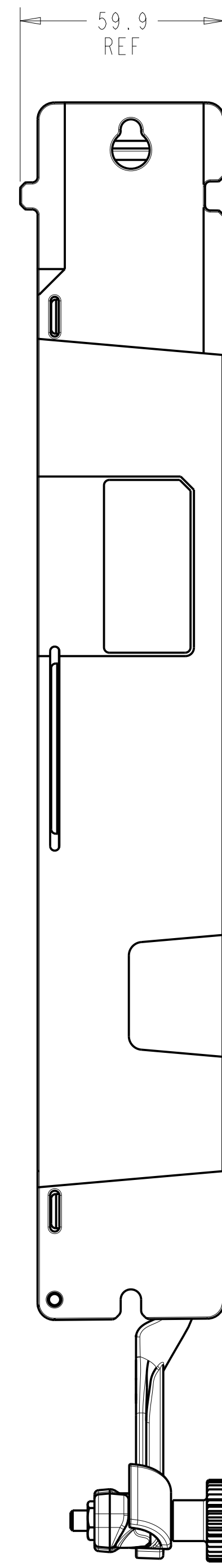
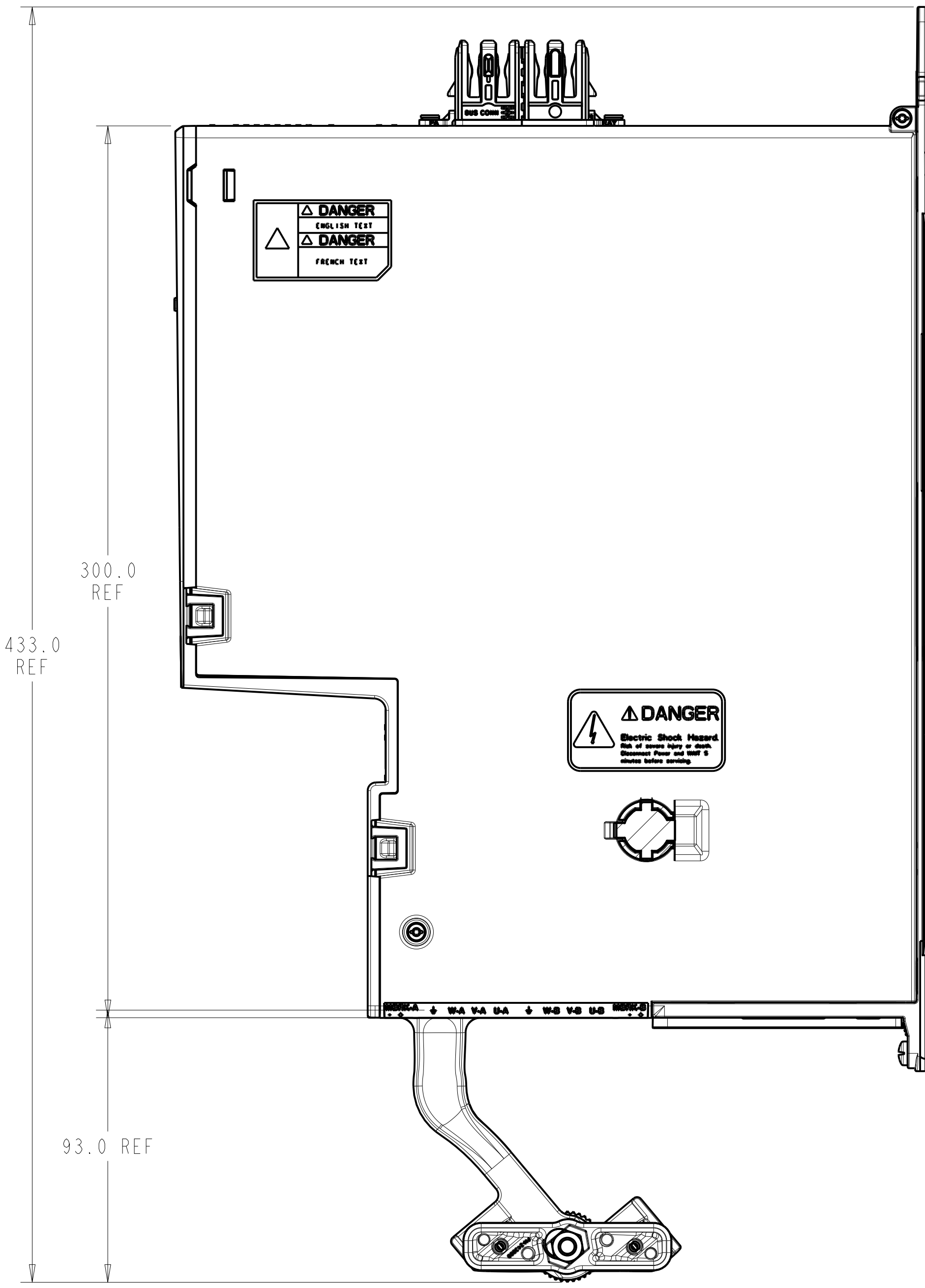
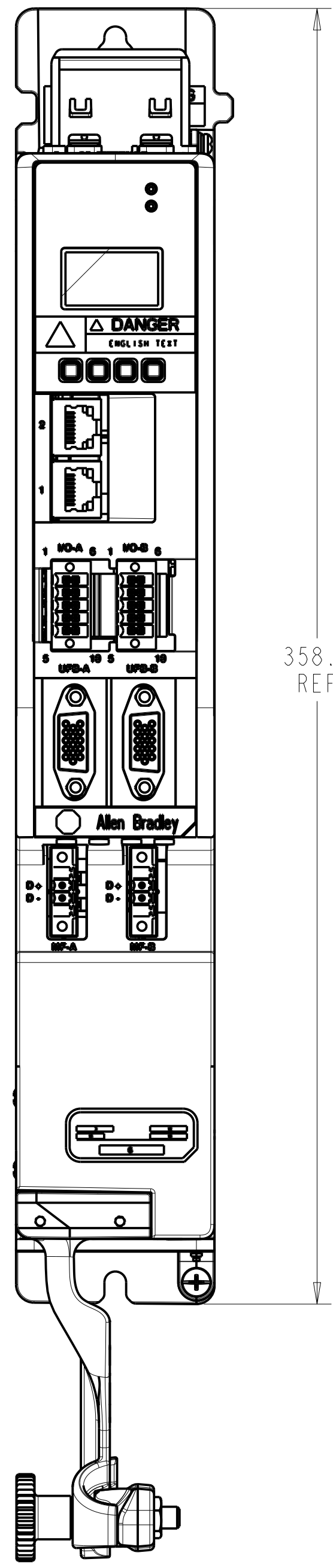
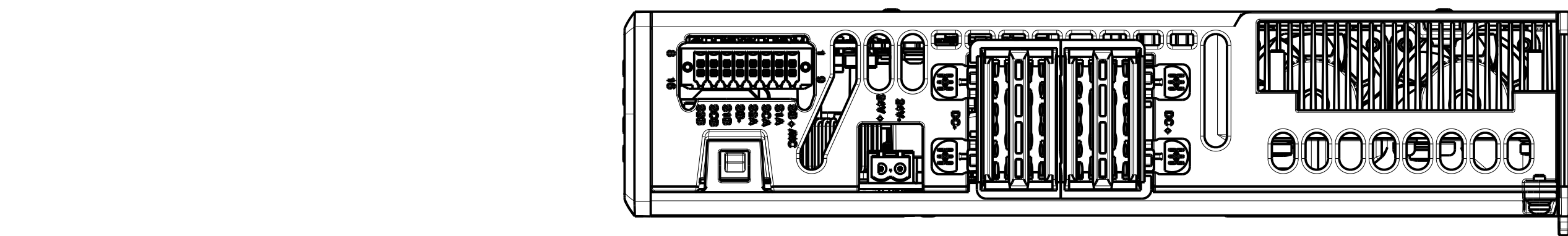

SCALE
0.600

NOTES:
1. DIMENSIONS ARE IN MILLIMETERS

SCALE 0.800

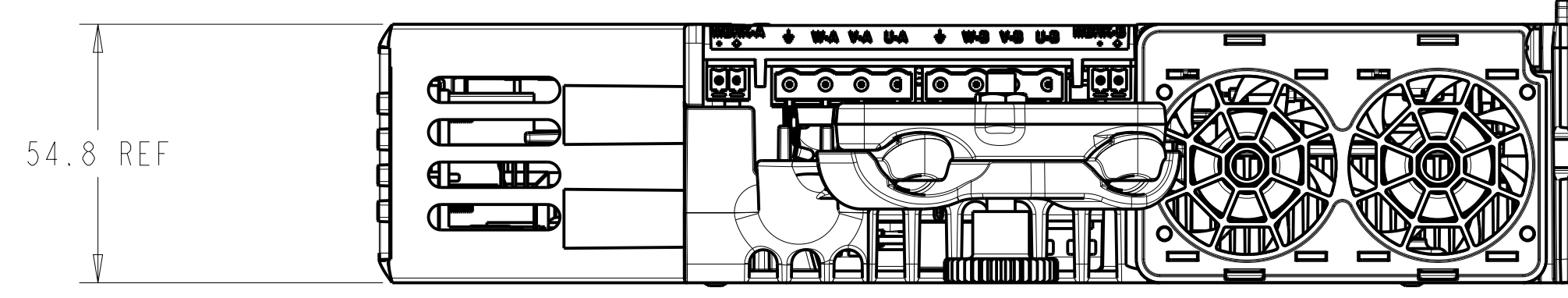

MUST COMPLY WITH ROCKWELL AUTOMATION ENVIRONMENTAL SPECIFICATION 970-20-01

DIMENSION UNITS - mm	
UNLESS SPECIFIED THE FOLLOWING TOLERANCES APPLY (ISO/DIN MEDIUM).	
.X:±	N/A
.XX:±	N/A
ANG:±	N/A

ALL UNDIMENSIONED GEOMETRIES ARE CONTROLLED BY THE CAD MODEL. IN CASE OF DIMENSION DISCREPANCY, CAD MODEL OVERRIDES.

THIRD ANGLE PROJECTION



OUTLINE DRAWING 2198-DOXX-ERS4

CREATED BY:NMWIEBER

CHANGED BY:PTHAKRE

CONFIDENTIAL AND PROPRIETARY INFORMATION. THIS DOCUMENT CONTAINS CONFIDENTIAL AND PROPRIETARY INFORMATION OF ROCKWELL AUTOMATION, INC. AND MAY NOT BE USED, COPIED OR DISCLOSED TO OTHERS, EXCEPT WITH THE AUTHORIZED WRITTEN PERMISSION OF ROCKWELL AUTOMATION, INC.	
DATE:2020-03-13	SHEET 1 OF 1
SIZE D1R	VER
10006361739	00