

1 2 3 4 5 6 7 8

A
B
C
D
E
F
G
H

A
B
C
D
E
F
G
H

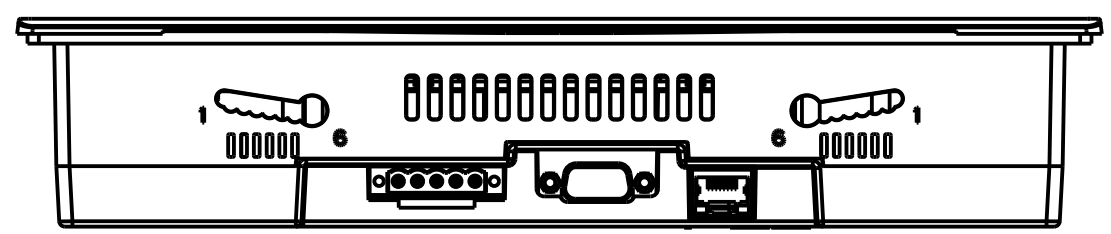
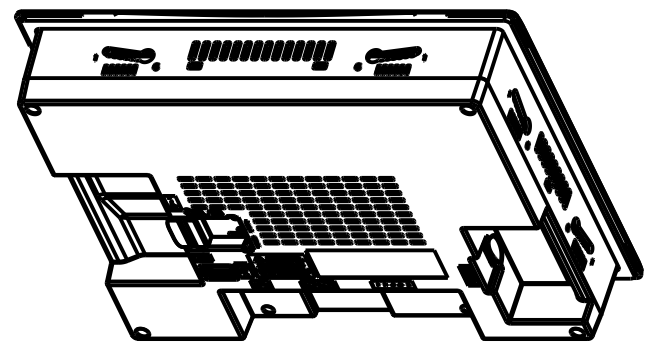
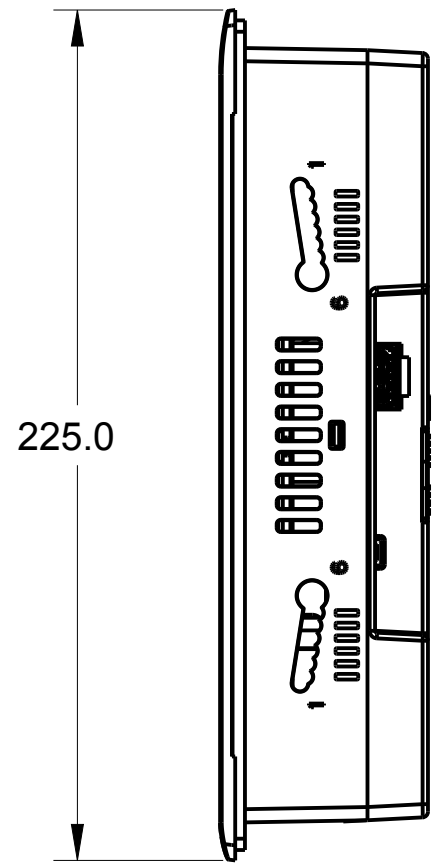
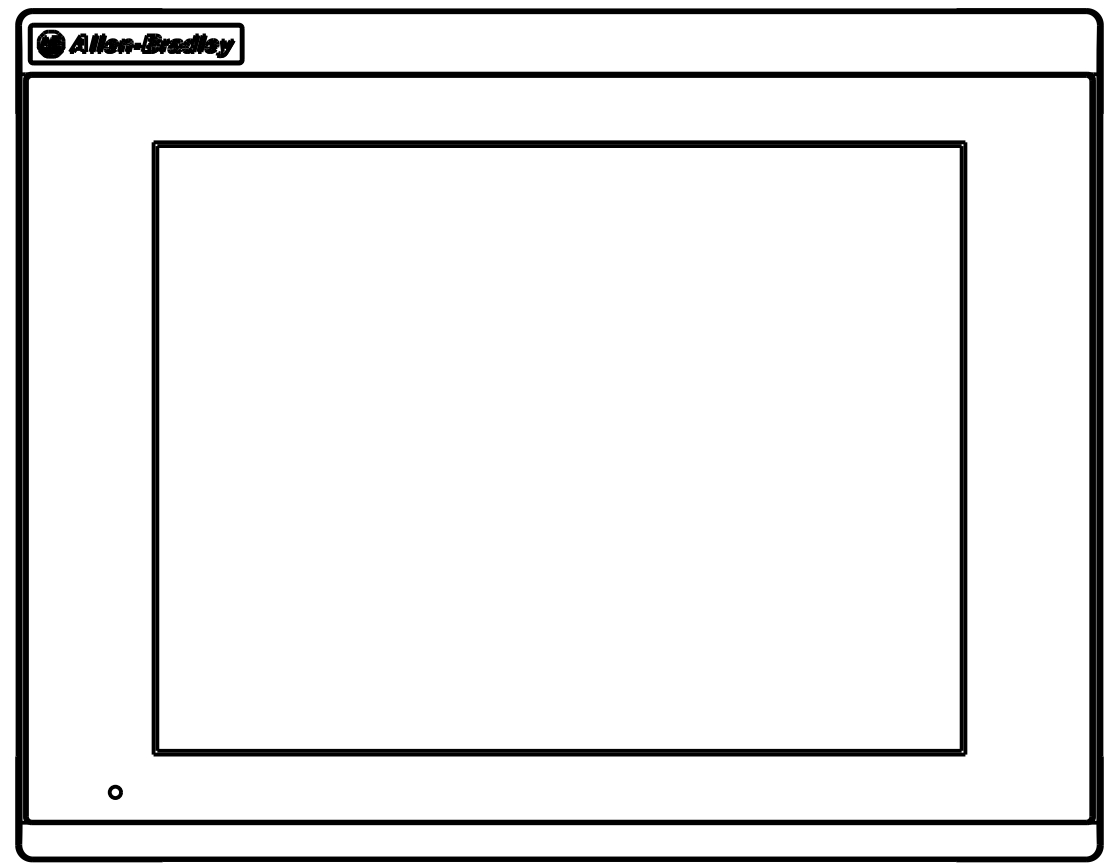
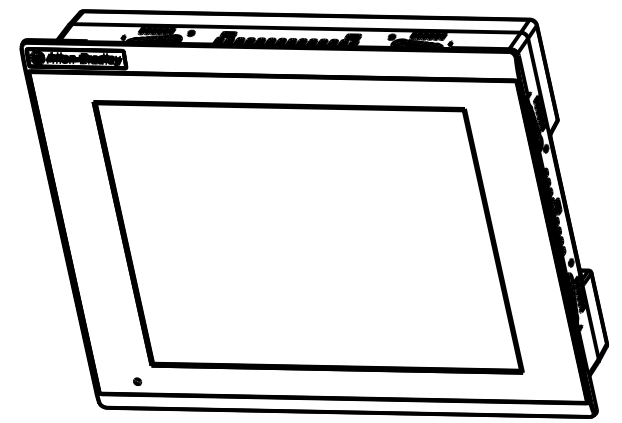
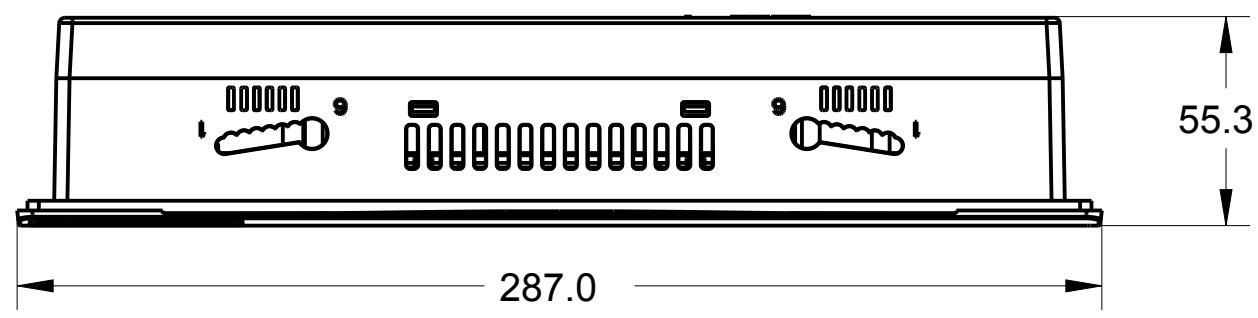

MUST COMPLY WITH ROCKWELL AUTOMATION ENVIRONMENTAL SPECIFICATION 970-20-01

ALL UNDIMENSIONED GEOMETRIES ARE CONTROLLED BY THE CAD MODEL. IN CASE OF DIMENSION DISCREPANCY, CAD MODEL OVERRIDES.

THIRD ANGLE PROJECTION

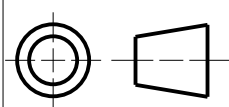

SCALE 0.500

Rockwell Automation

271R-T10T PANELVIEW 2D

CONFIDENTIAL AND PROPRIETARY INFORMATION. THIS DOCUMENT CONTAINS CONFIDENTIAL AND PROPRIETARY INFORMATION OF ROCKWELL AUTOMATION, INC. AND MAY NOT BE USED, COPIED OR DISCLOSED TO OTHERS, EXCEPT WITH THE AUTHORIZED WRITTEN PERMISSION OF ROCKWELL AUTOMATION, INC.

DATE:2019-01-16 SHEET 1 OF 1

SIZE	DIR	VER
B		01

CREATED BY:YSUPRIA

CHANGED BY:*****

1 2 3 4 5 6 7 8