

Installation and Operating Instructions

Bulletin 440P DIN 50047 IEC/Safety Limit Switch

IMPORTANT: Installation of Allen-Bradley/ Guardmaster products should be in accordance with local and/or national codes. Servicing energized industrial control equipment can be hazardous if not in accordance to recommended safety procedures.

Specifications

AC/DC Designation	A600; Q300
AC/DC Utilization Category	AC 15; DC 13
Max. Fusing rate	15A fast acting
Impulse Voltage (Uimp)	2500V
Enclosure Protection	IP66
Pollution Degree	3
Storage Temperature	80°C (176°F)/-25°C (-13°F)
Operating Temperature	80°C (176°F)/-25°C (-13°F)
Direct Opening Action	Normally closed only (safety circuit)
Conductor Sizes	Use copper conductors only
Stranded	0.75mm ² to 2.5mm ² (0.02in ² to 0.09in ²) (18-14AWG)
Solid	0.75mm ² to 2.5mm ² (0.02in ² to 0.09in ²) (18-16AWG)

See the *Sensors* catalog for additional information and product selection.



ATTENTION: Operator heads with adjustable actuators are NOT intended for safety applications.

Torque/Mounting

Location	Torque
Heads	0.4-0.45Nm
Covers	0.4-0.45Nm
M5 Mounting	2.5-3.0Nm
Wire Clamp	0.9-1.0Nm
Lever Clamp	1.4-1.5Nm
Conduit	1.0Nm

Dimensions—mm (inches)

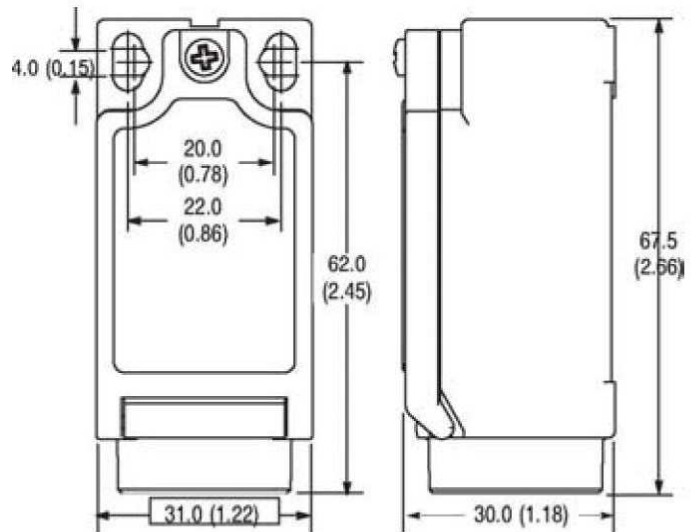

Rotating Operator Heads

When rotating operator heads, follow these steps:

1. Loosen the head mounting screws and remove the operating head from the switch enclosure.

IMPORTANT: Internal operator head components can become dislodged when removing operator heads. Use caution during removal and assembly.

2. Orient the operator head in 1 of the 4 positions offered. Make sure the loose parts are positioned correctly before affixing the operator head to the switch enclosure.
3. Tighten the 4 screws per the recommended torque specifications above.

IMPORTANT: Check for switch operation with a continuity indicator before placing product in service.

