

Bus Bar Approximate Dimensions

Note: Dimensions are shown in millimeters (inches). Dimensions are not intended for manufacturing purposes.

1-Phase Bus Bars

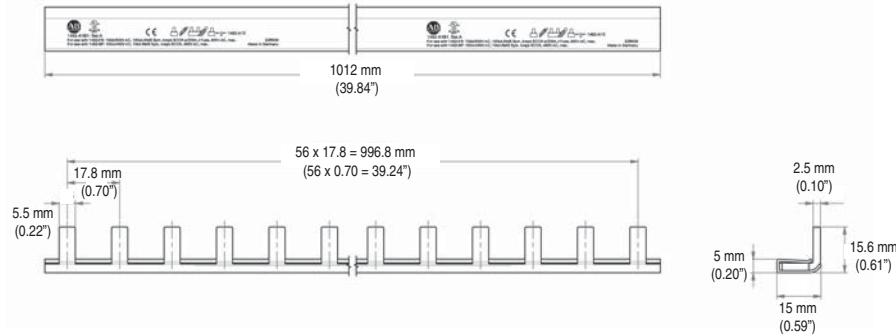

1492-A1B1

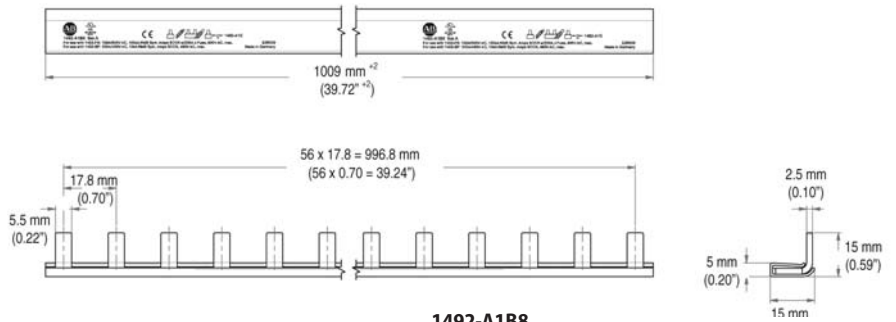

1492-A1B8

1-Phase Bus Bars, with Auxiliary Contact

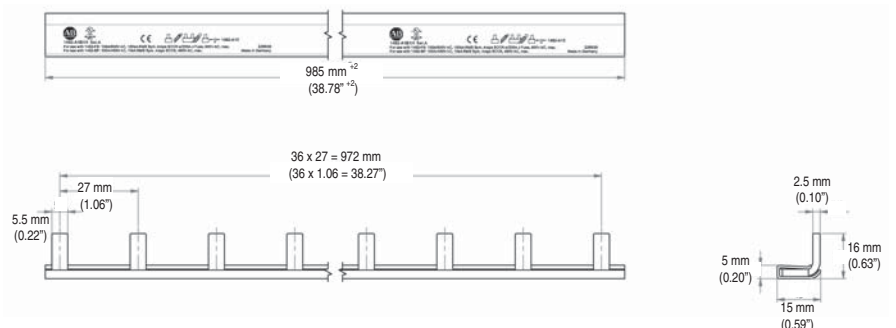

1492-A1B1H

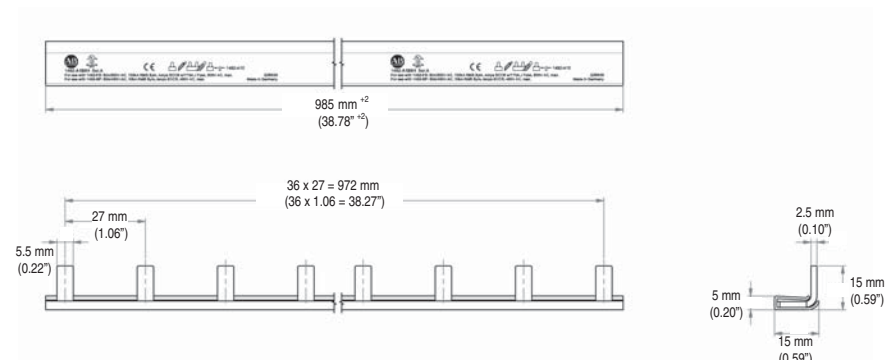

1492-A1B8H

Bus Bar Approximate Dimensions

Note: Dimensions are shown in millimeters (inches). Dimensions are not intended for manufacturing purposes.

2-Phase Bus Bars

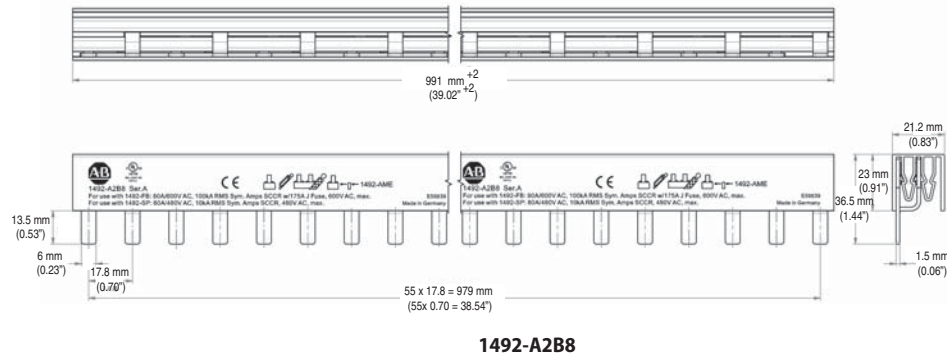
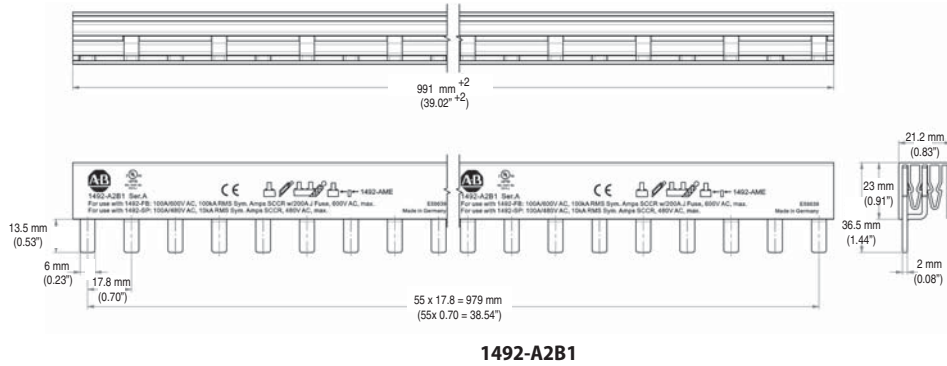

2-Phase Bus Bars, with Auxiliary Contact

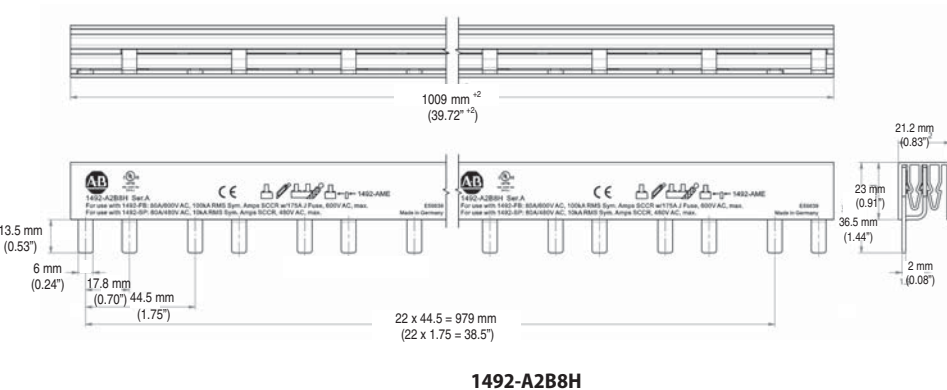
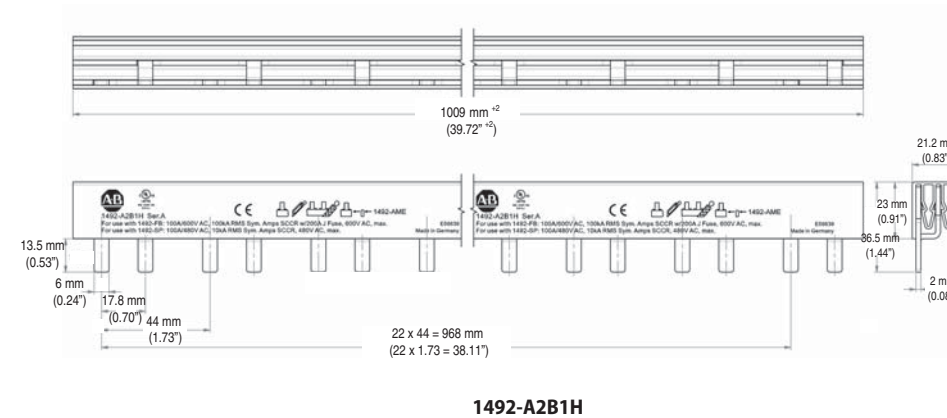

Bus Bar Approximate Dimensions

Note: Dimensions are shown in millimeters. Dimensions are not intended for manufacturing purposes.

3-Phase Bus Bars

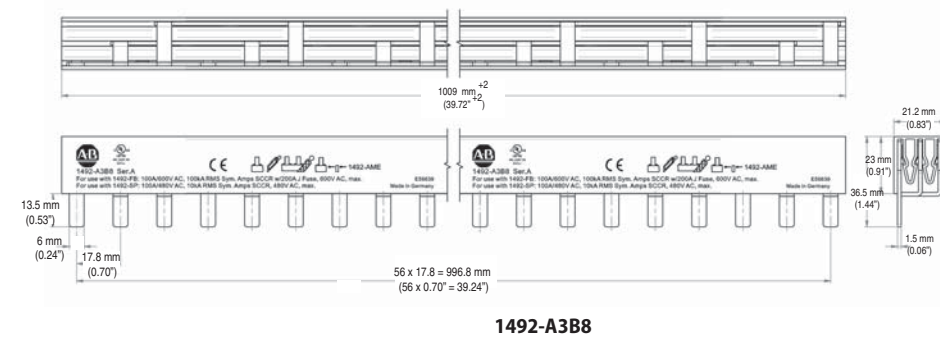
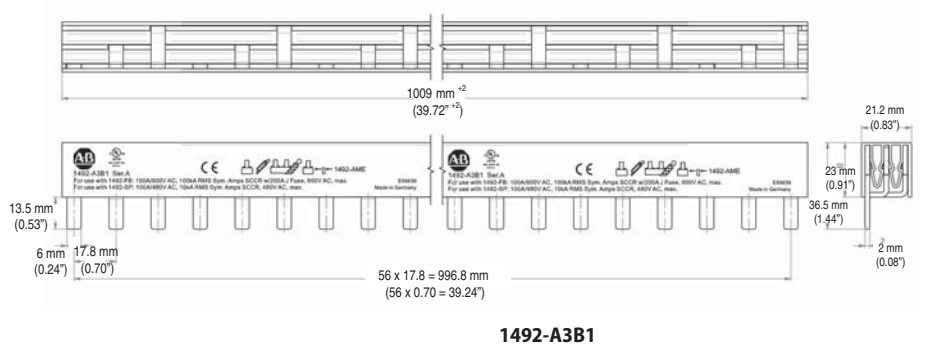

3-Phase Bus Bars, with Auxiliary Contact

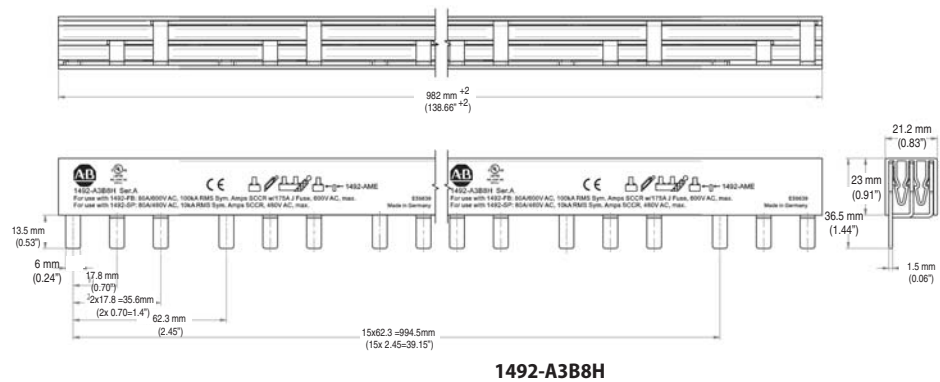
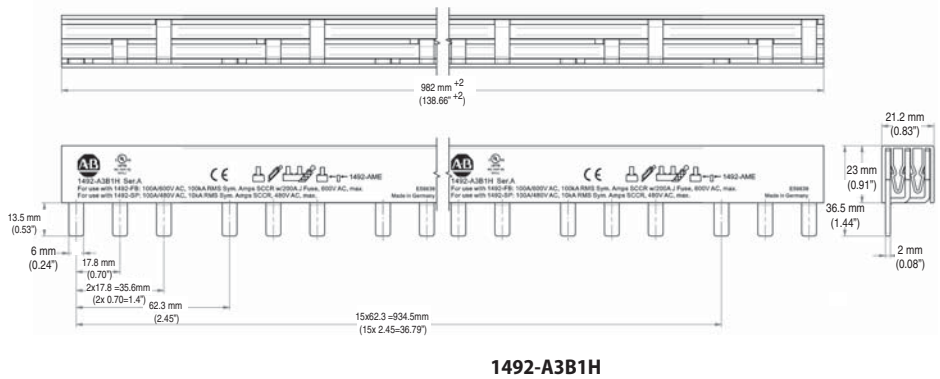

Bus Bar Accessory Approximate Dimensions

Note: Dimensions are shown in millimeters. Dimensions are not intended for manufacturing purposes.

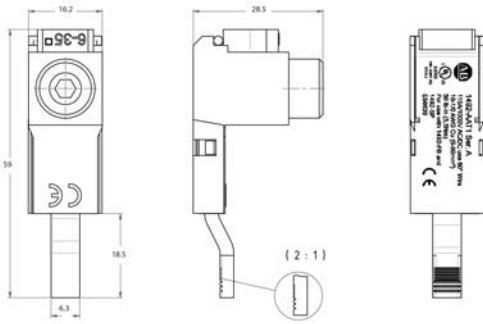

1492-AAT1

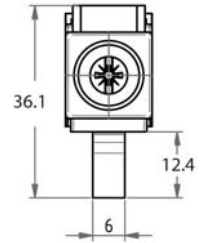
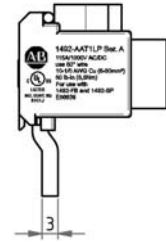
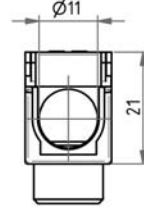

1492-AAT1LP

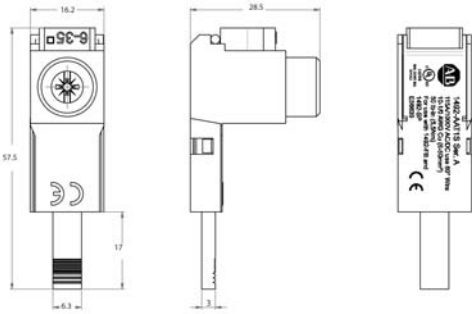

1492-AAT1S

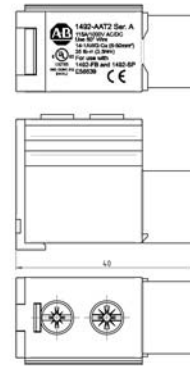
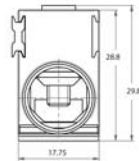

1492-AAT2

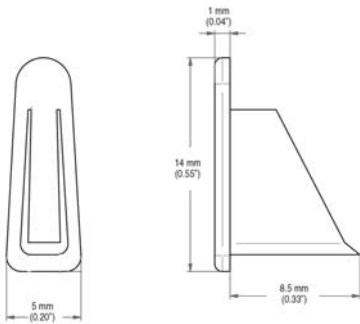

1492-A1E

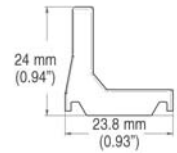
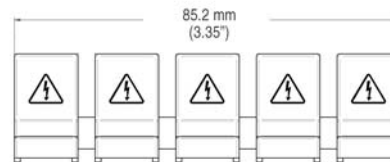

1492-AAP

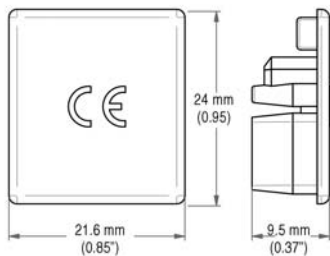

1492-AME