

1 2 3 4 5 6 7 8

A B C D E F G H

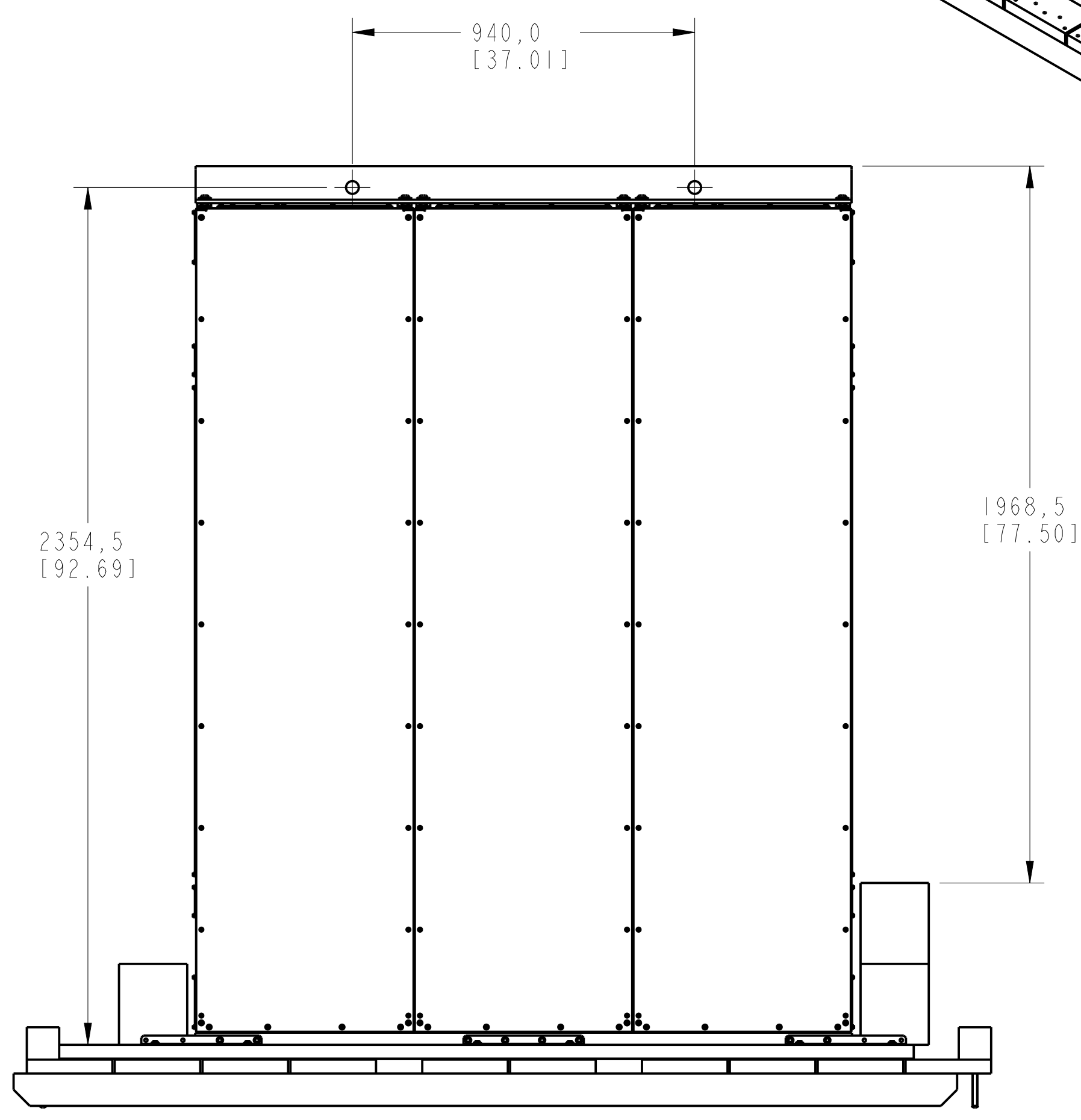
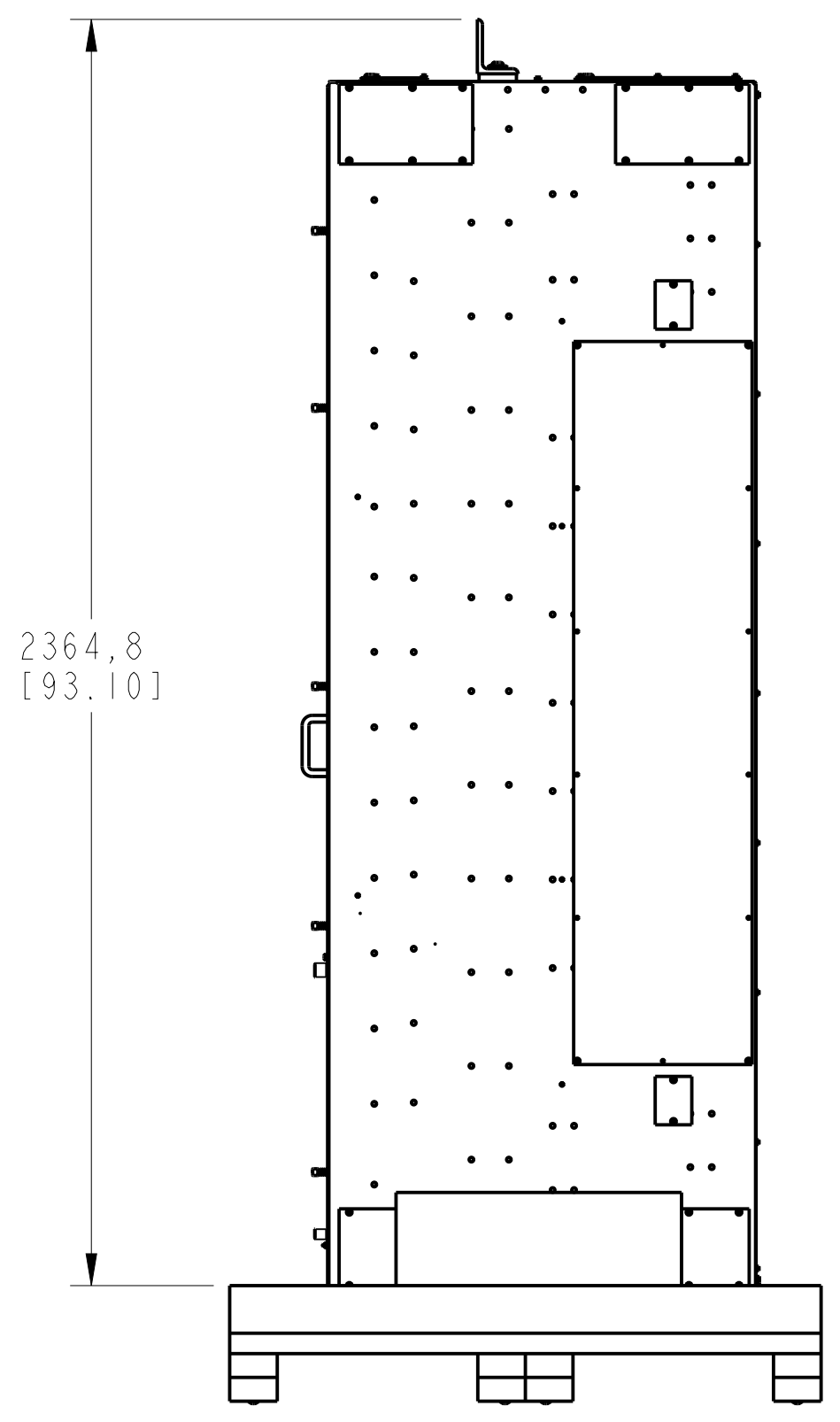
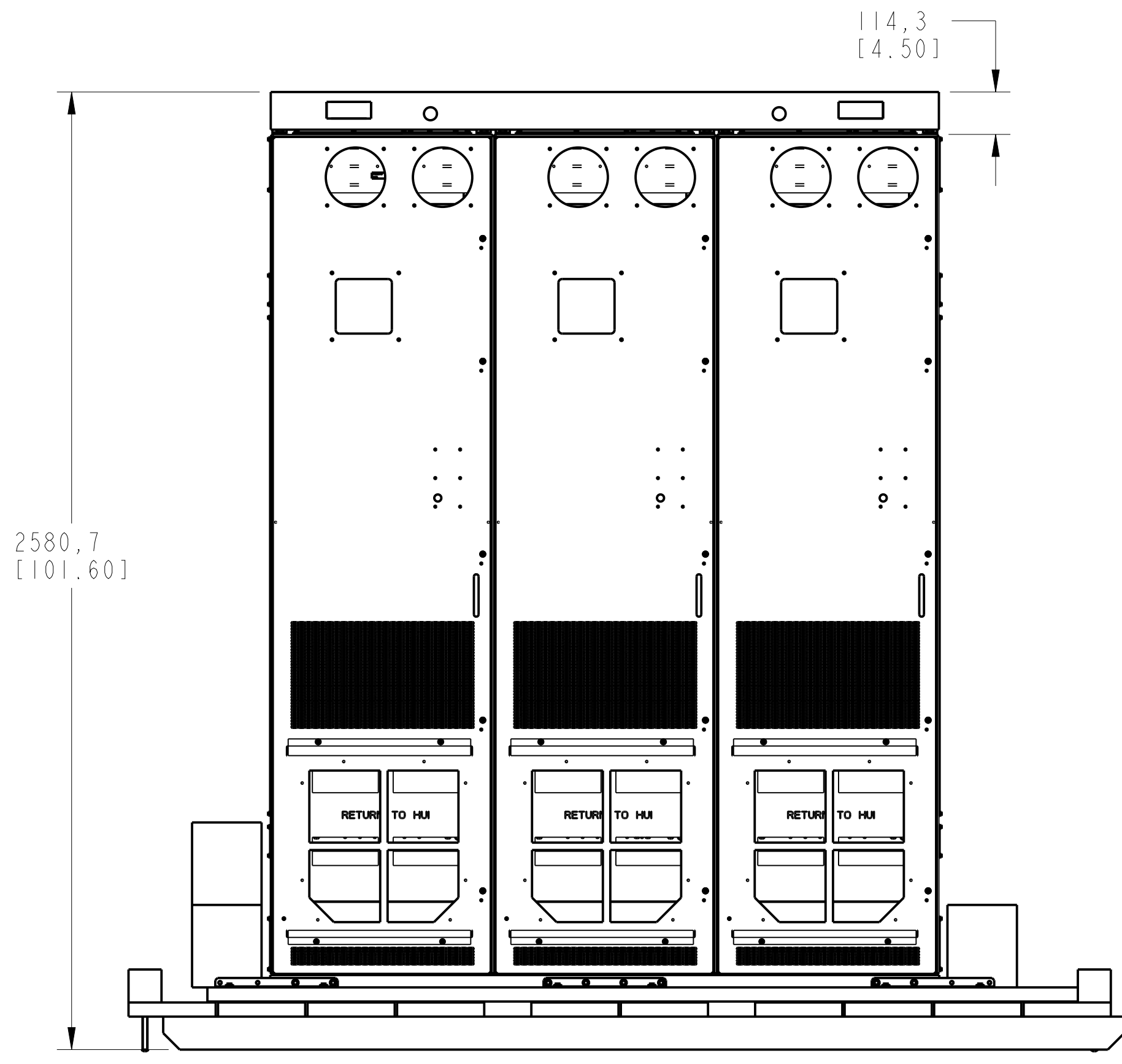
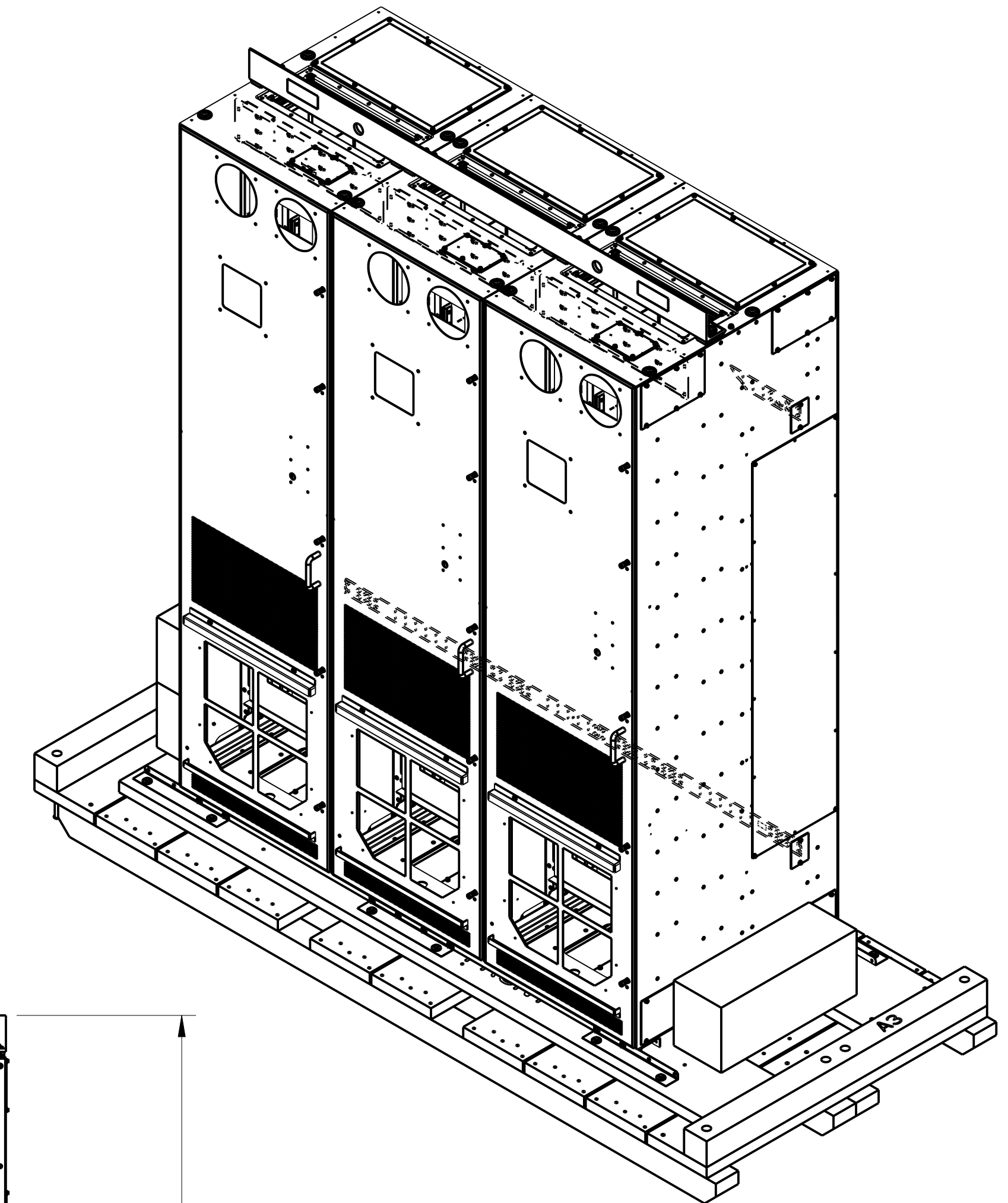
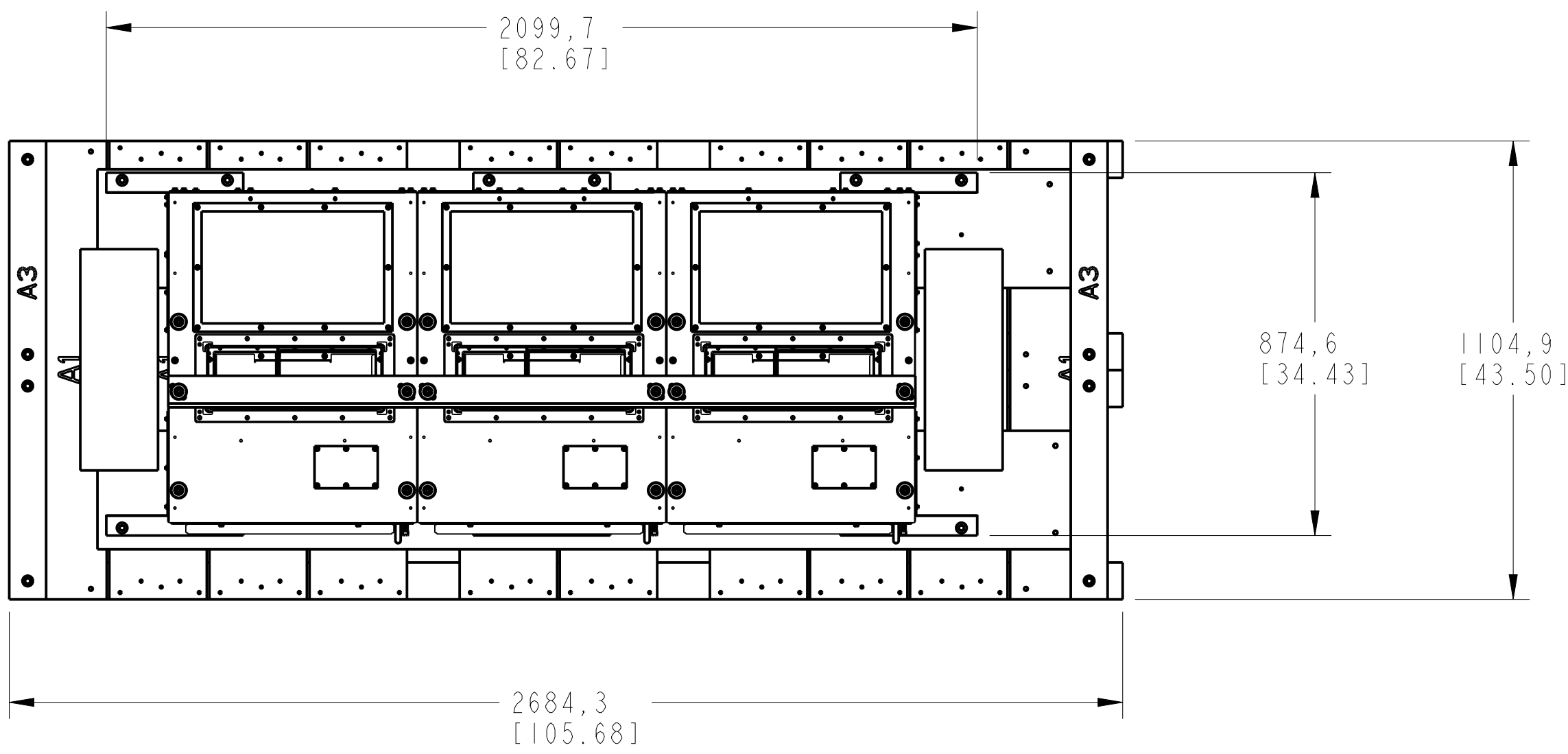

FRAME 10 TYPE 1 / IP20 DRIVE BAY
 PN-392949
 PN-392976

DIMENSIONS APPLY BEFORE SURFACE TREATMENT
 DIMENSIONS IN MILLIMETERS
 TOLERANCES UNLESS OTHERWISE SPECIFIED

| | |
|------|--------|
| .X: | ± 0,8 |
| .XX: | ± 0,51 |
| ANG: | ± 1° |

Rockwell Automation

STANDARD PF750-FRAME-10-AC-800mm-IP20

Drawn by: RSUBRAMI Date: APR-28-2017

CONFIDENTIAL AND PROPRIETARY INFORMATION
 THIS DOCUMENT CONTAINS CONFIDENTIAL AND PROPRIETARY INFORMATION OF ROCKWELL AUTOMATION, INC. AND MAY NOT BE USED, COPIED OR DISCLOSED TO OTHERS, EXCEPT WITH THE AUTHORIZED WRITTEN PERMISSION OF ROCKWELL AUTOMATION, INC.

| | |
|-------|-------------|
| Sheet | 15 Of 36 |
| Size | D |
| Ver | 10 |
| | 10000222178 |

1 2 3 4 5 6 7 8

A B C D E F G H

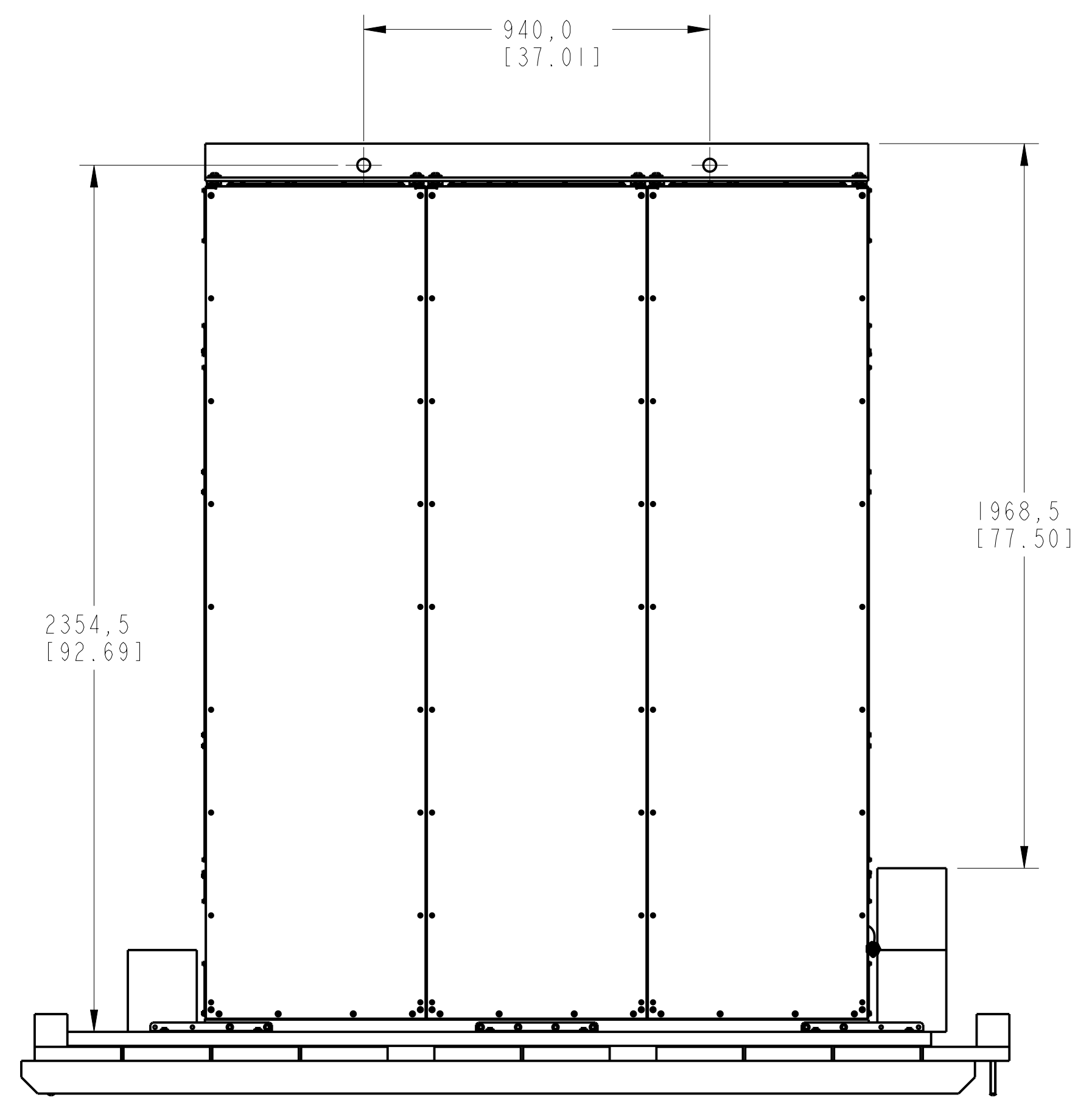
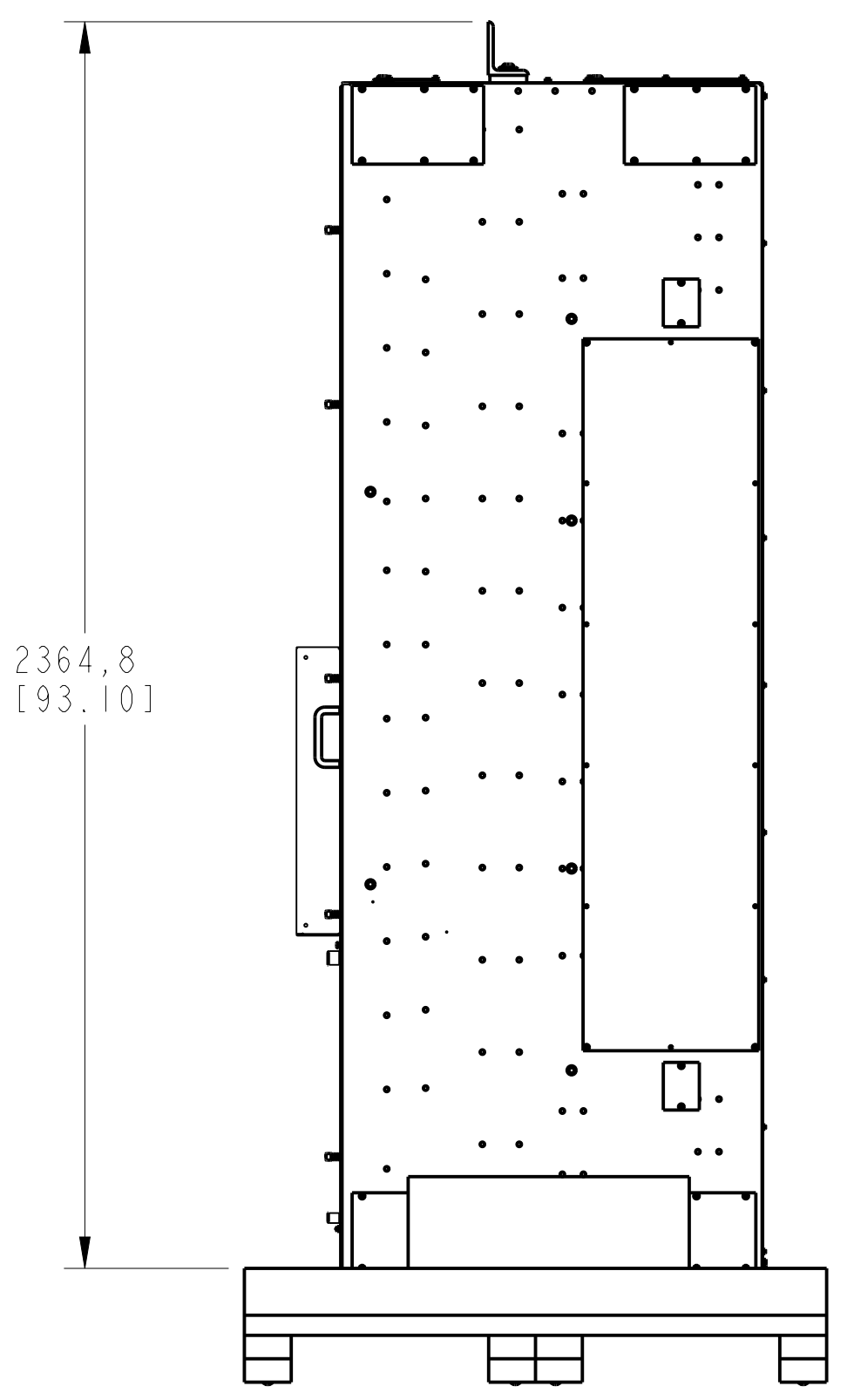
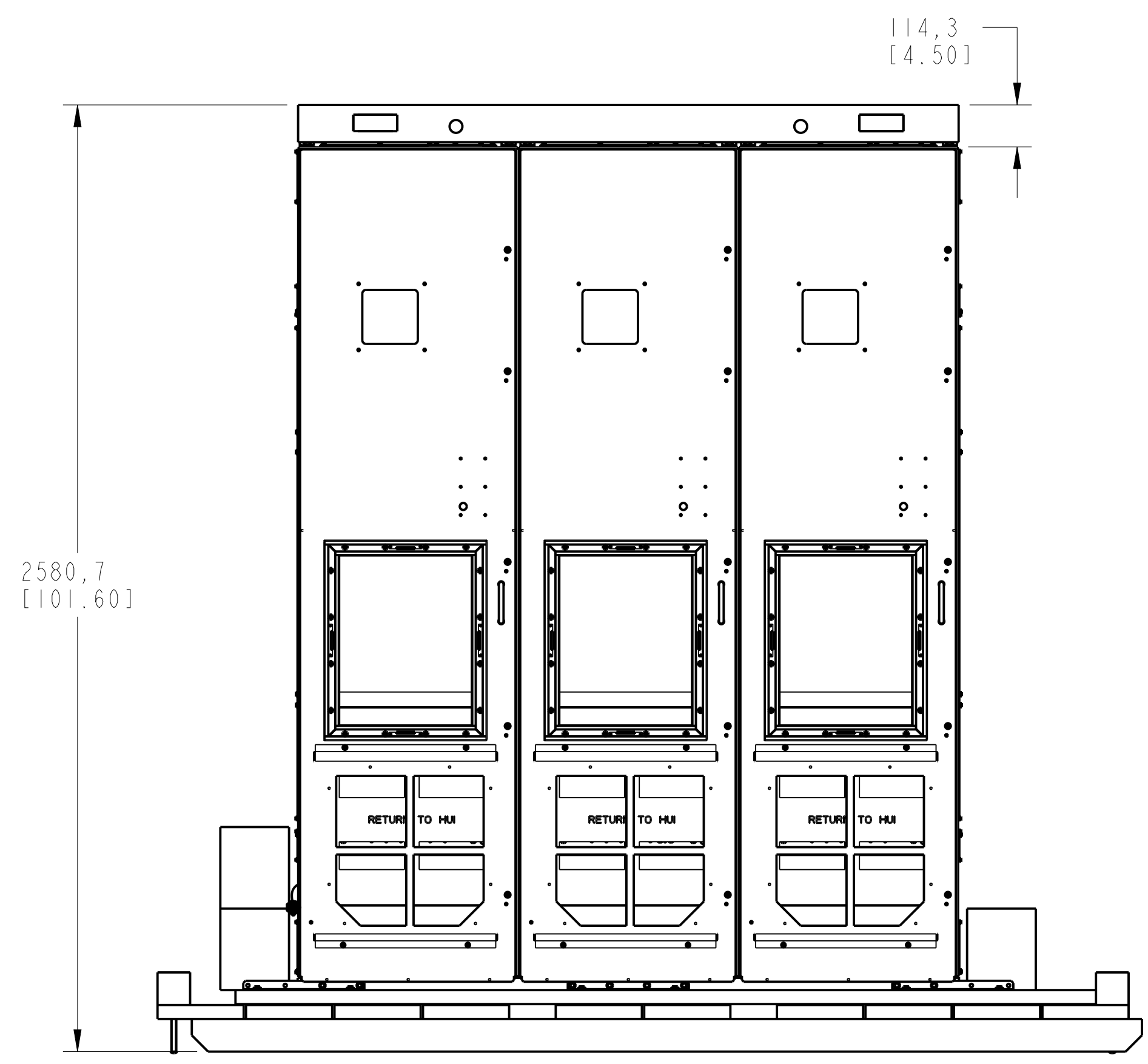
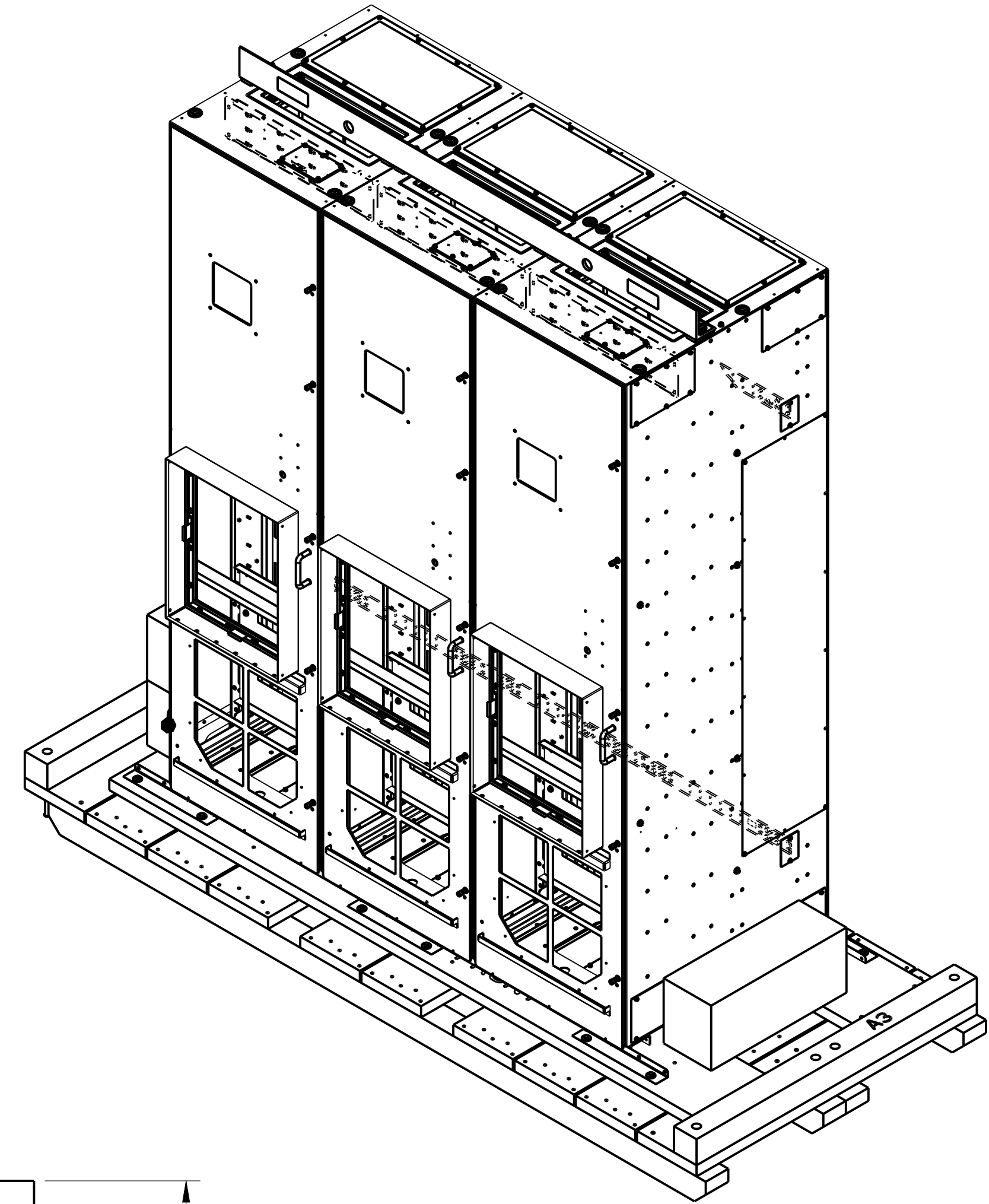
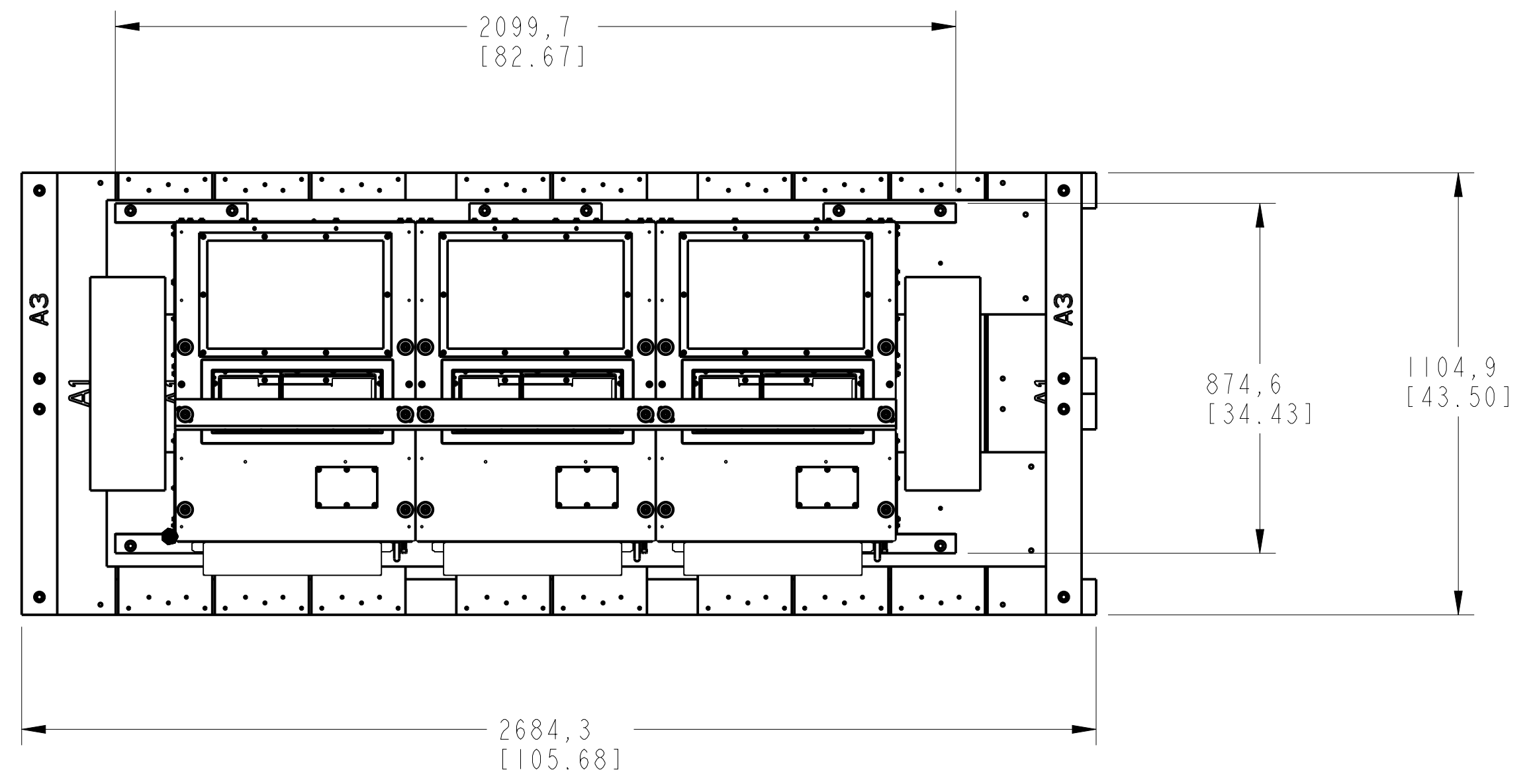

FRAME 10 TYPE 12 / IP54 DRIVE BAY
PN-393196
PN-393228

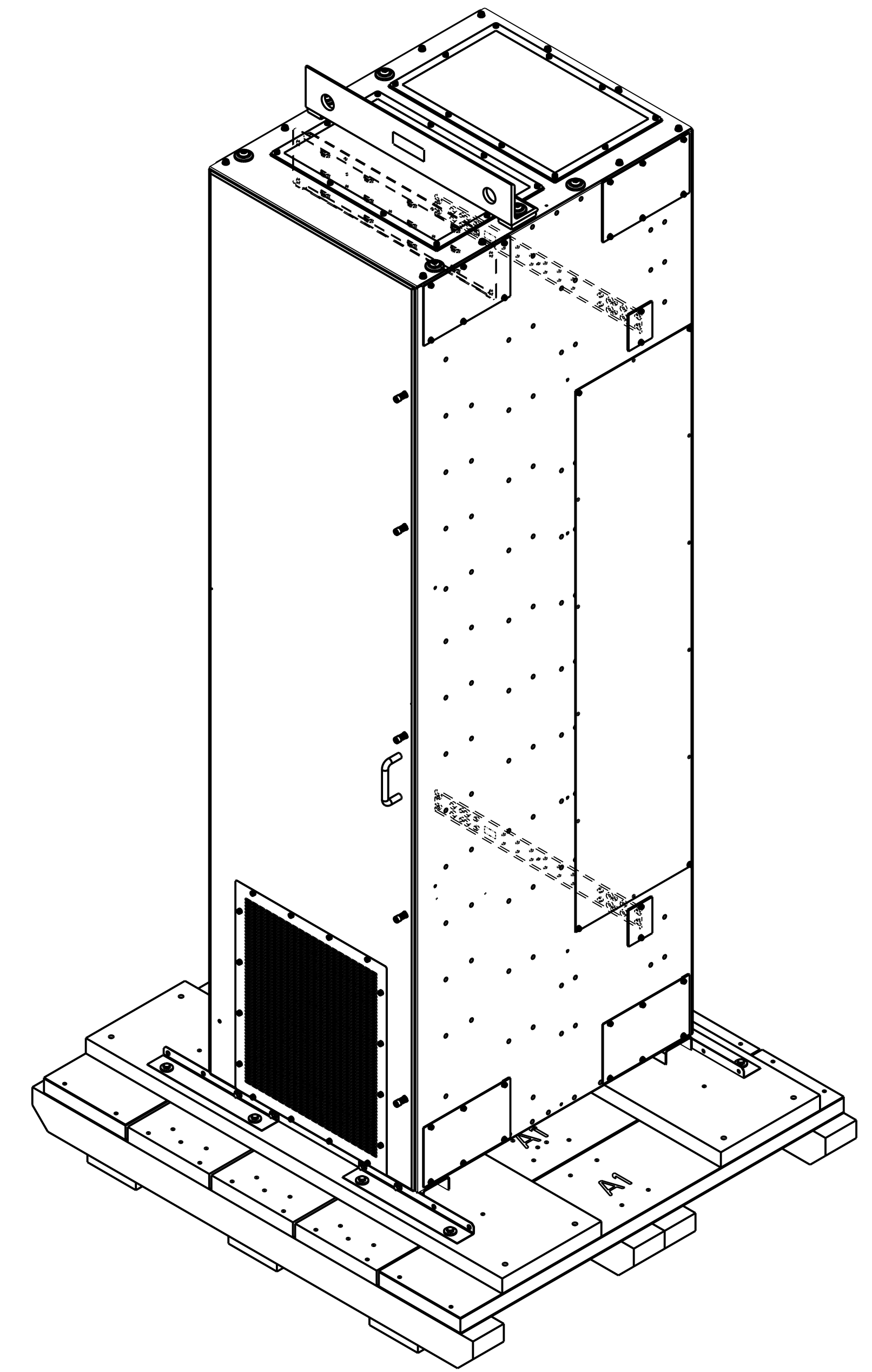
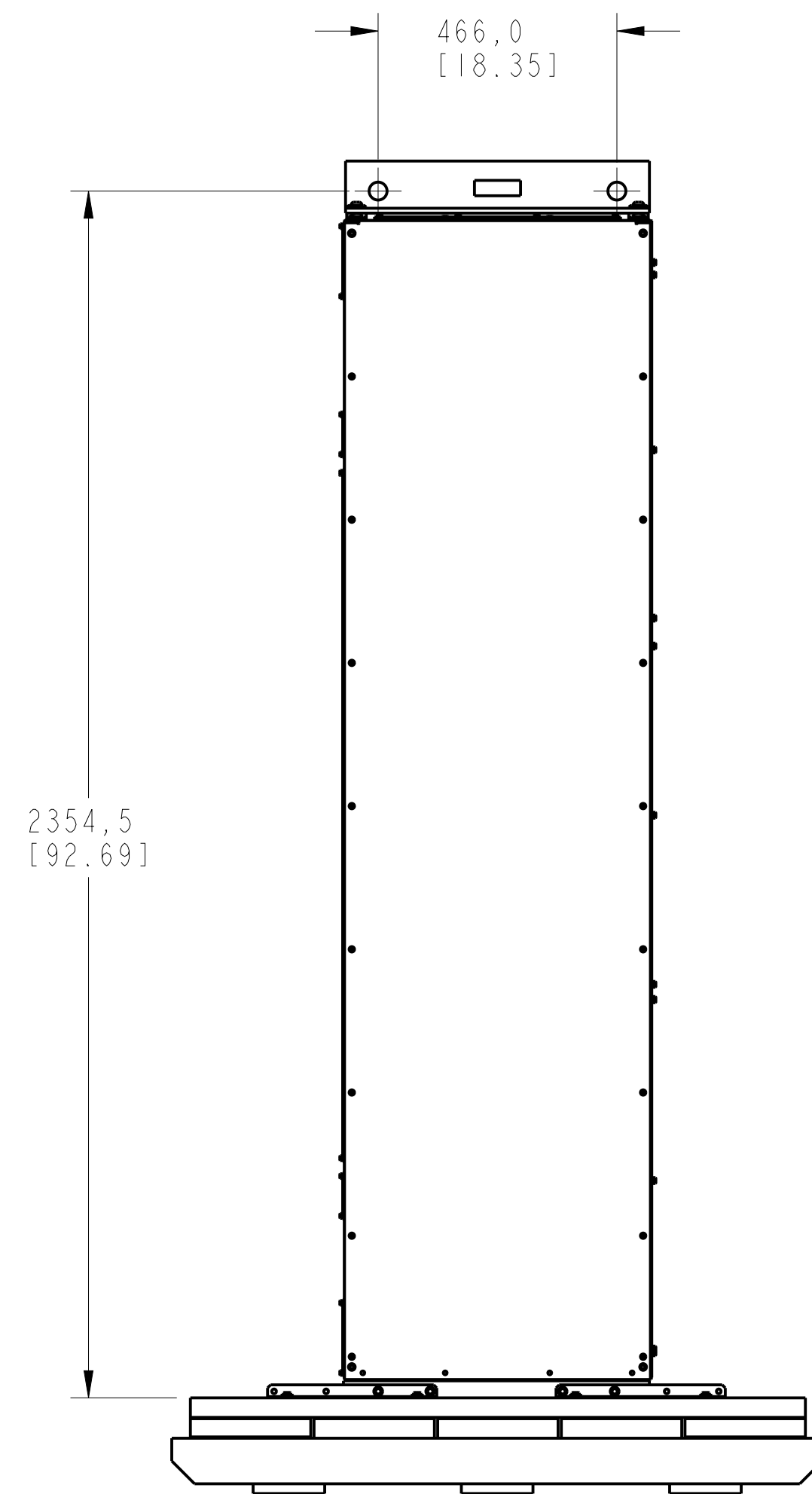
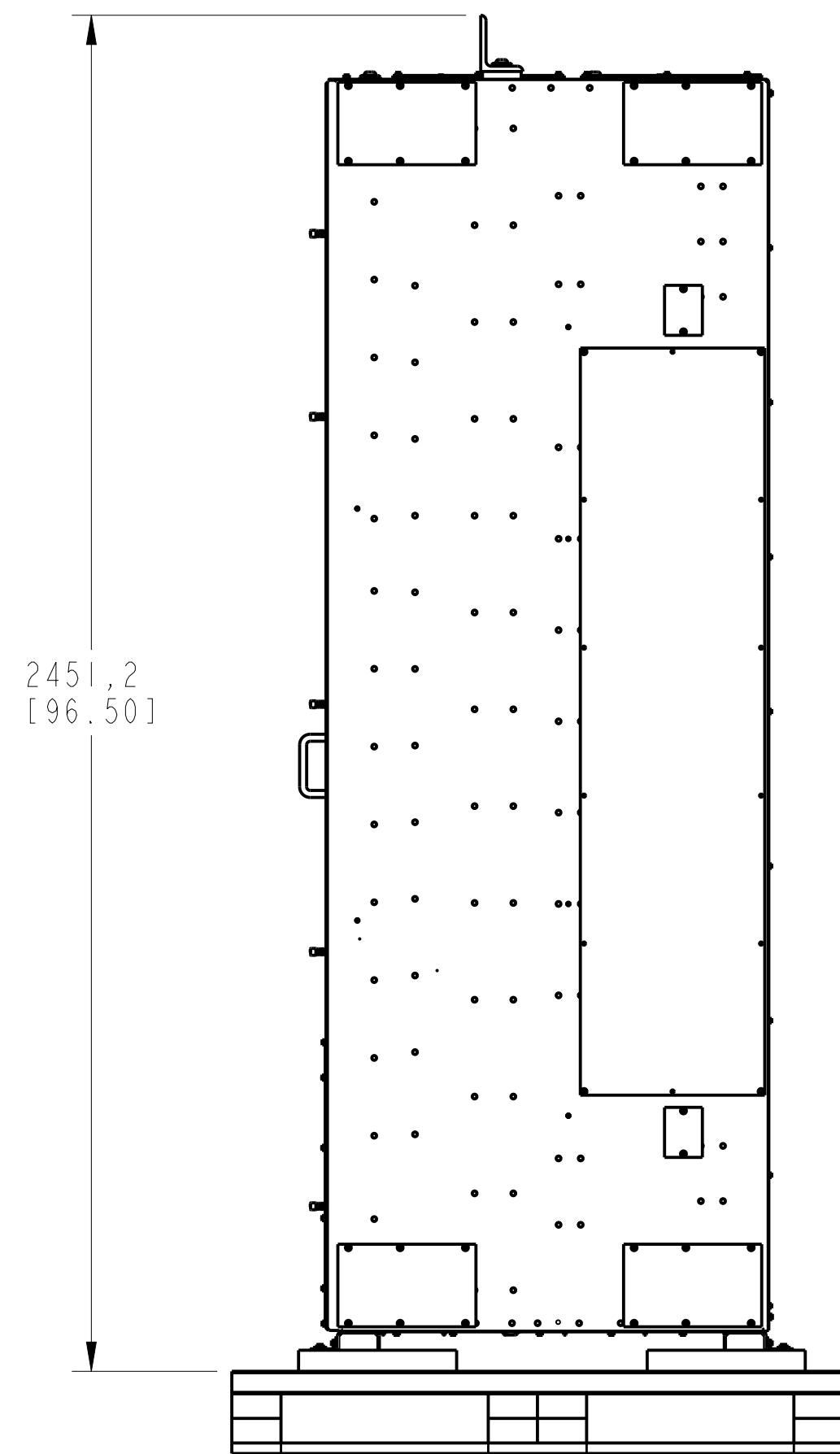
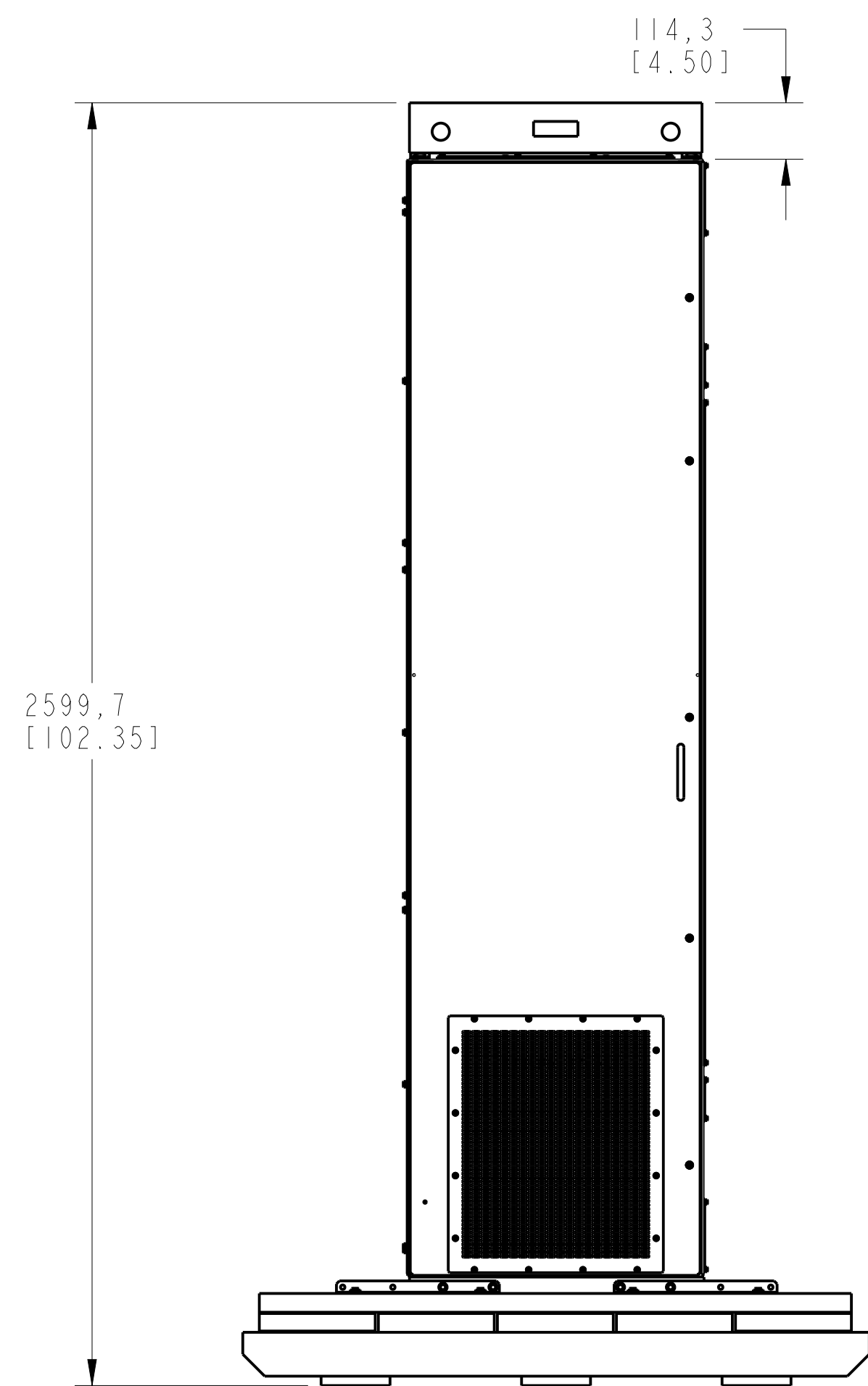
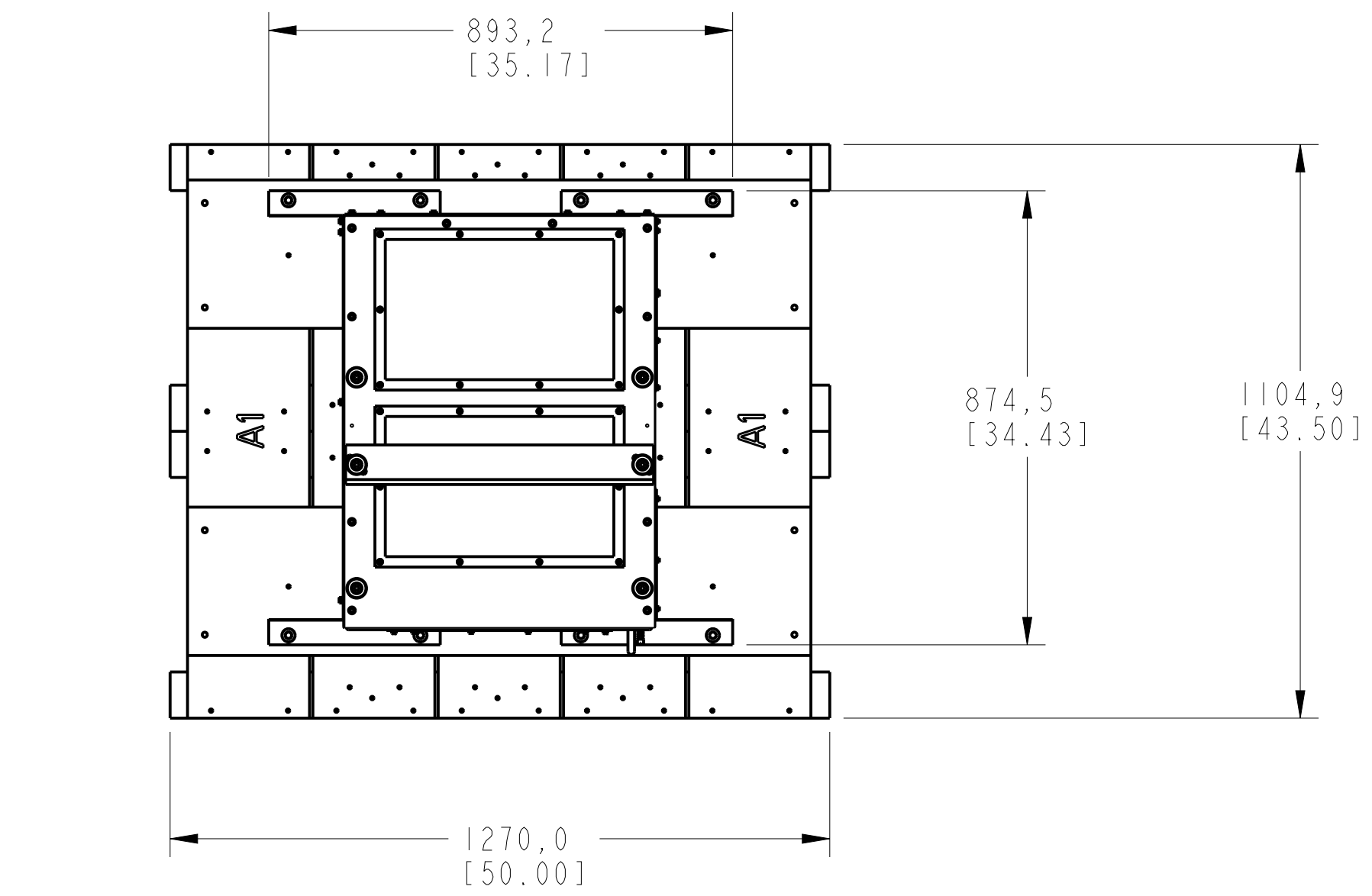

FRAME 10 TYPE 1 / IP20 DRIVE ADD WIRE BAY
 PN-392972
 PN-392957

DIMENSIONS APPLY BEFORE SURFACE TREATMENT
 DIMENSIONS IN MILLIMETERS
 TOLERANCES UNLESS OTHERWISE SPECIFIED

| | |
|-------|------|
| .X:± | 0,8 |
| .XX:± | 0,51 |
| ANG:± | 1° |

Rockwell Automation

STANDARD PF750-FRAME-10-AC-800mm
 WIRING BAY-IP20

Drawn by: RSUBRAMI Date: APR-28-2017

CONFIDENTIAL AND PROPRIETARY INFORMATION
 THIS DOCUMENT CONTAINS CONFIDENTIAL AND PROPRIETARY INFORMATION OF ROCKWELL AUTOMATION, INC. AND MAY NOT BE USED, COPIED OR DISCLOSED TO OTHERS, EXCEPT WITH THE AUTHORIZED WRITTEN PERMISSION OF ROCKWELL AUTOMATION, INC.

| | |
|----------------|-----|
| Sheet 17 Of 36 | Ver |
| 10000222178 | 10 |

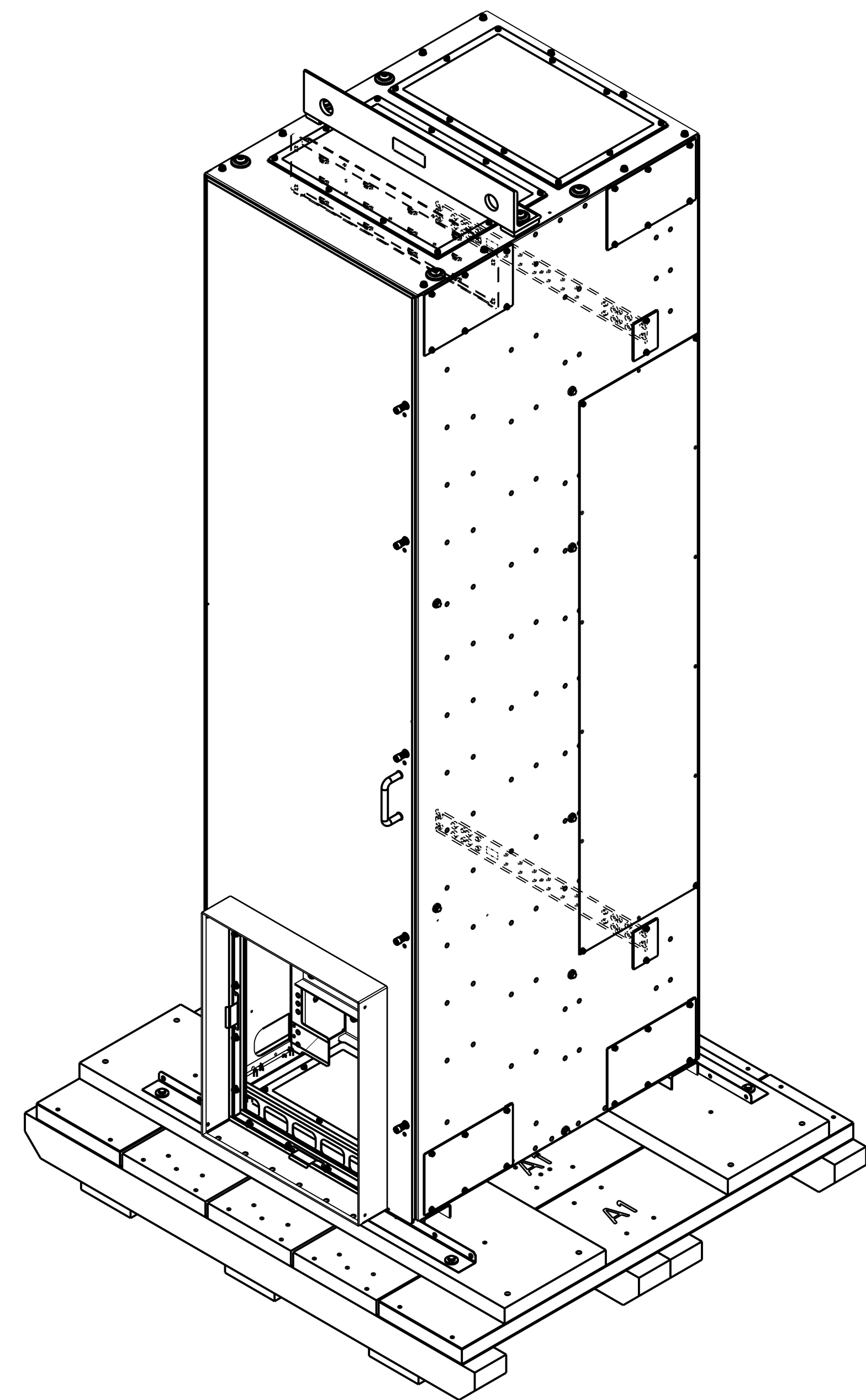
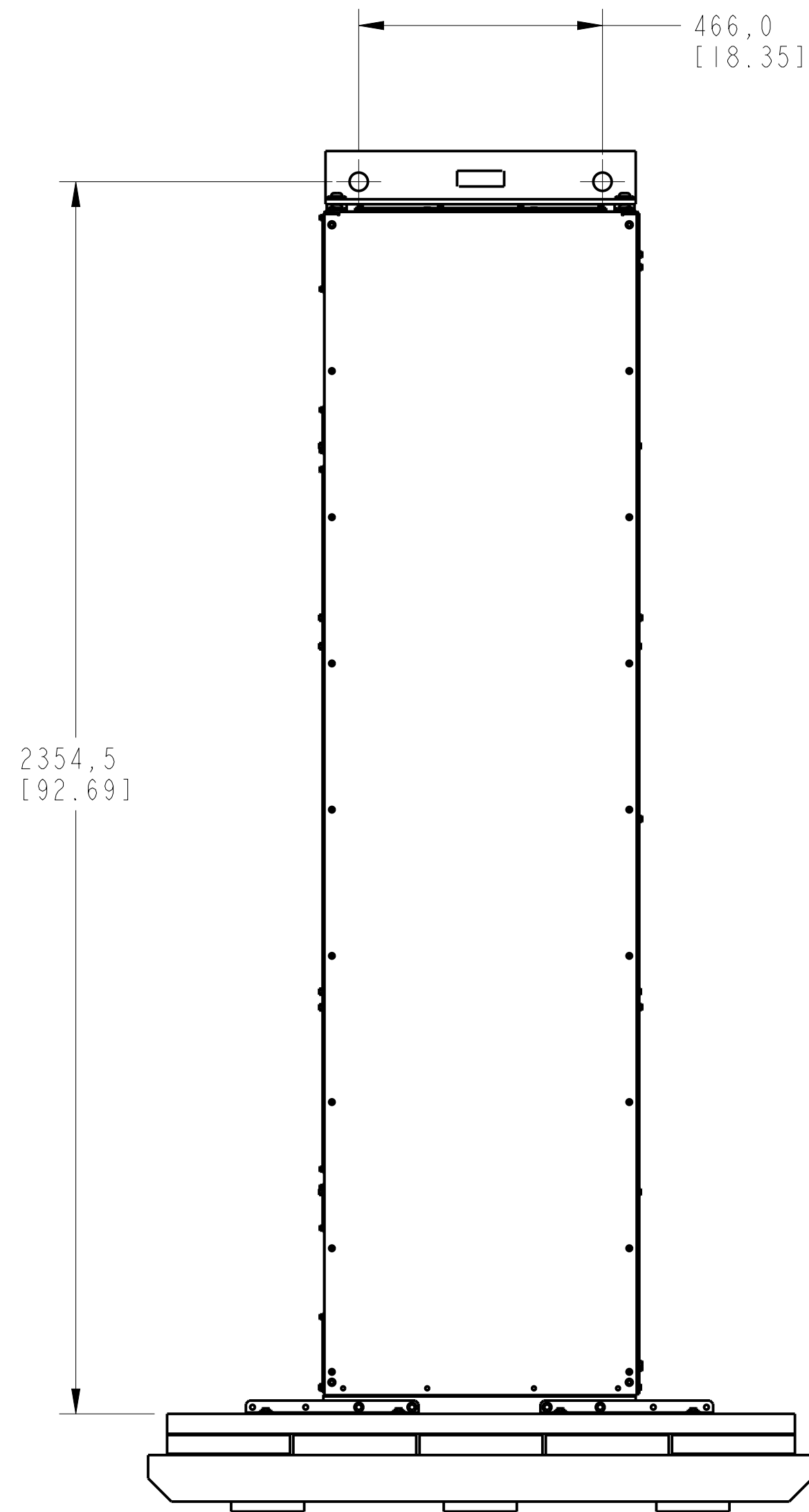
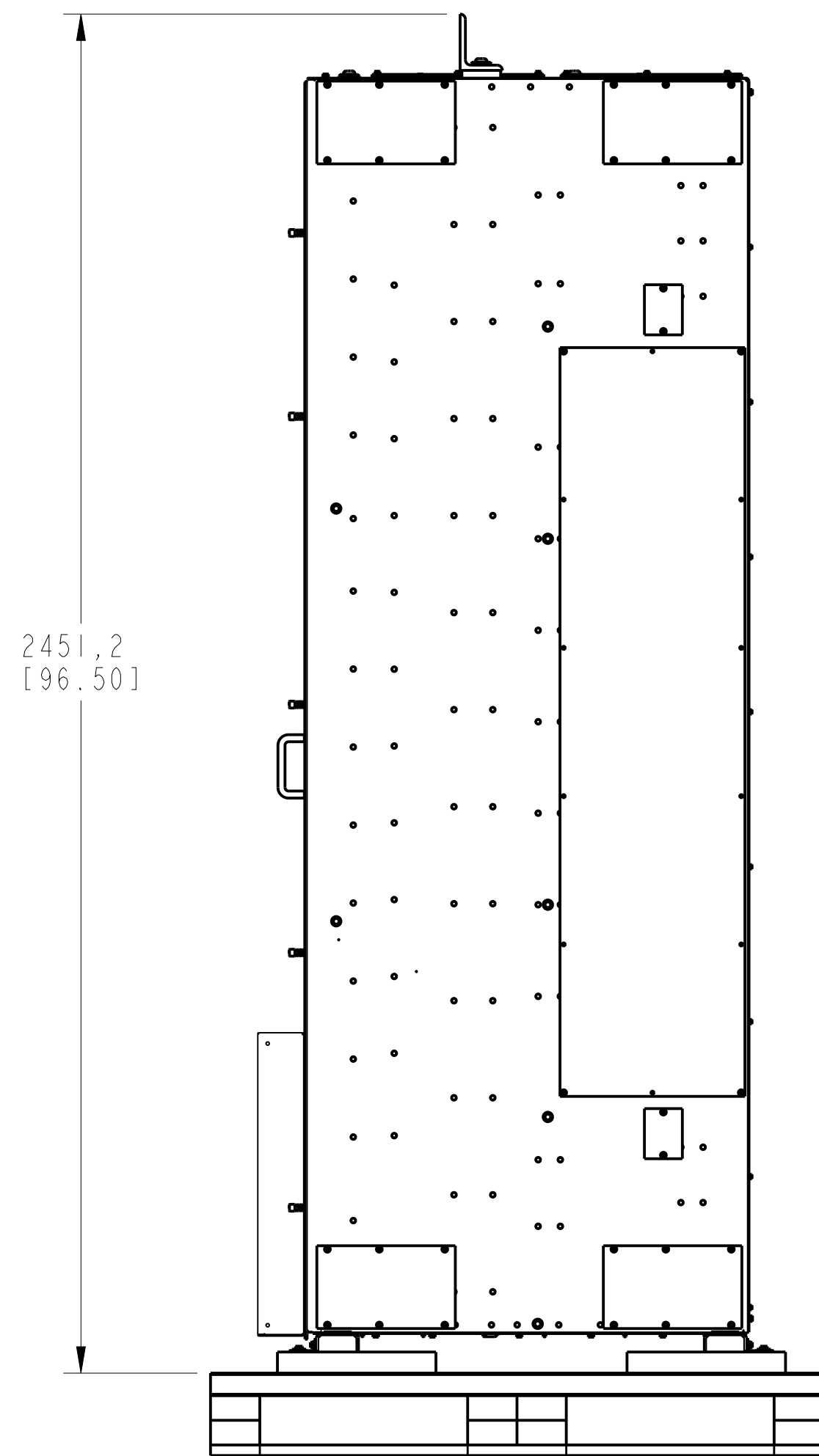
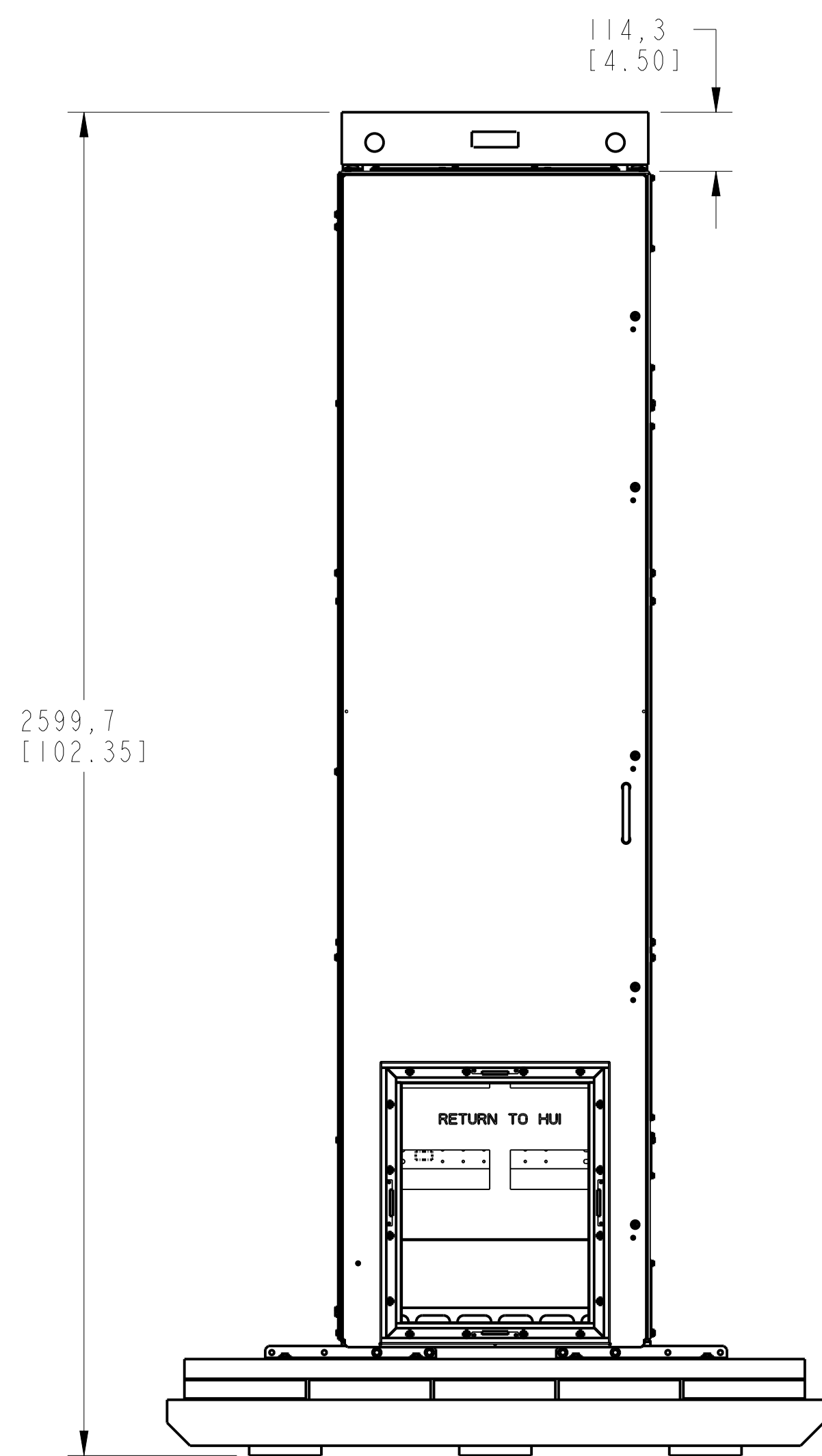
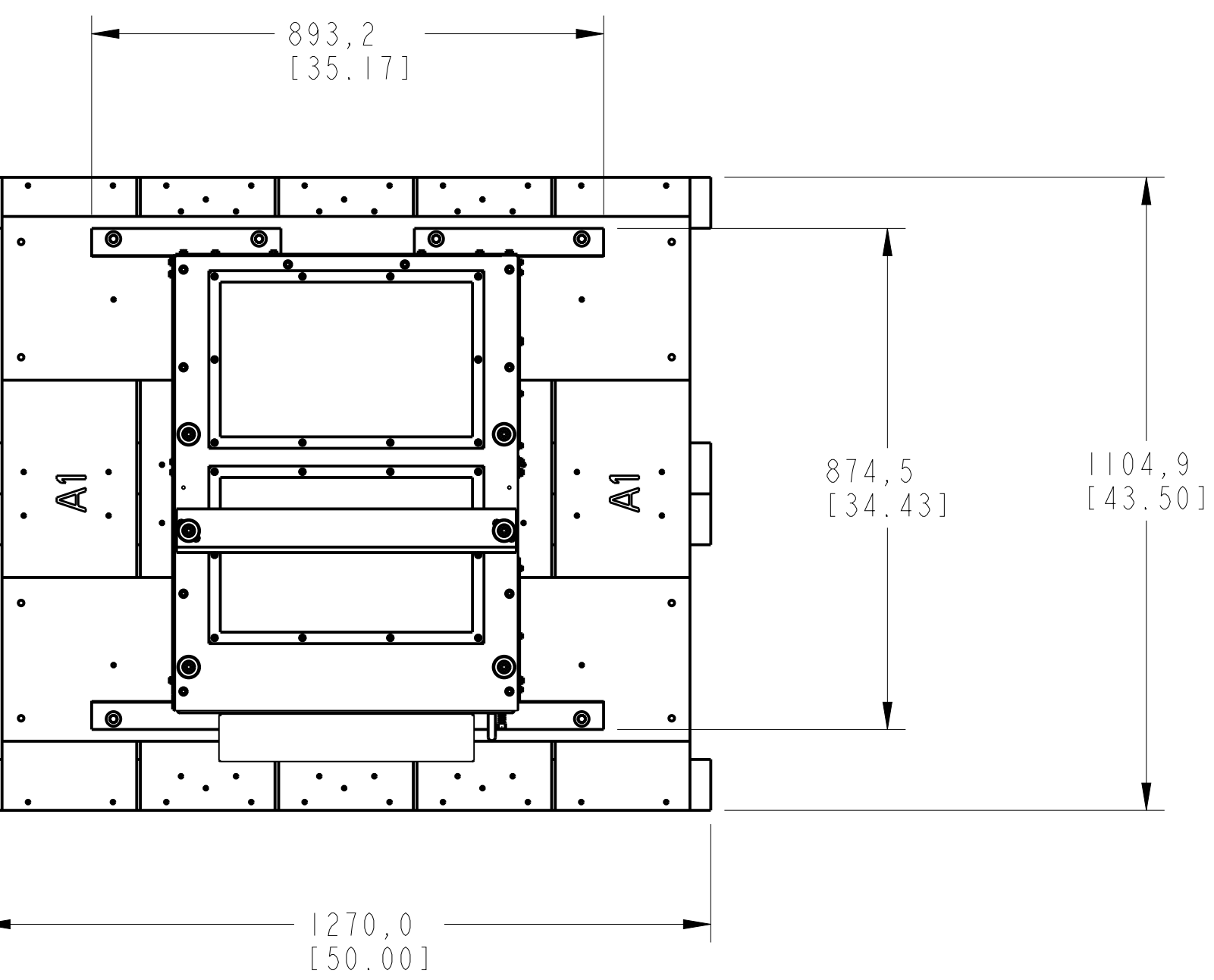

FRAME 10 TYPE 12 / IP54 DRIVE ADD WIRE BAY
 PN-393210
 PN-393226

| | | | |
|--------------------|--|--|----------------|
| | | <small>CONFIDENTIAL AND PROPRIETARY INFORMATION. THIS DOCUMENT CONTAINS CONFIDENTIAL AND PROPRIETARY INFORMATION OF ROCKWELL AUTOMATION, INC. AND MAY NOT BE USED, COPIED OR DISCLOSED TO OTHERS, EXCEPT WITH THE AUTHORIZED WRITTEN PERMISSION OF ROCKWELL AUTOMATION, INC.</small> | |
| | | STANDARD PF750-FRAME-10-AC-800mm WIRING BAY-IP54 | Sheet 18 Of 36 |
| Drawn by: RSUBRAMI | | Date: OCT-30-2020 | |

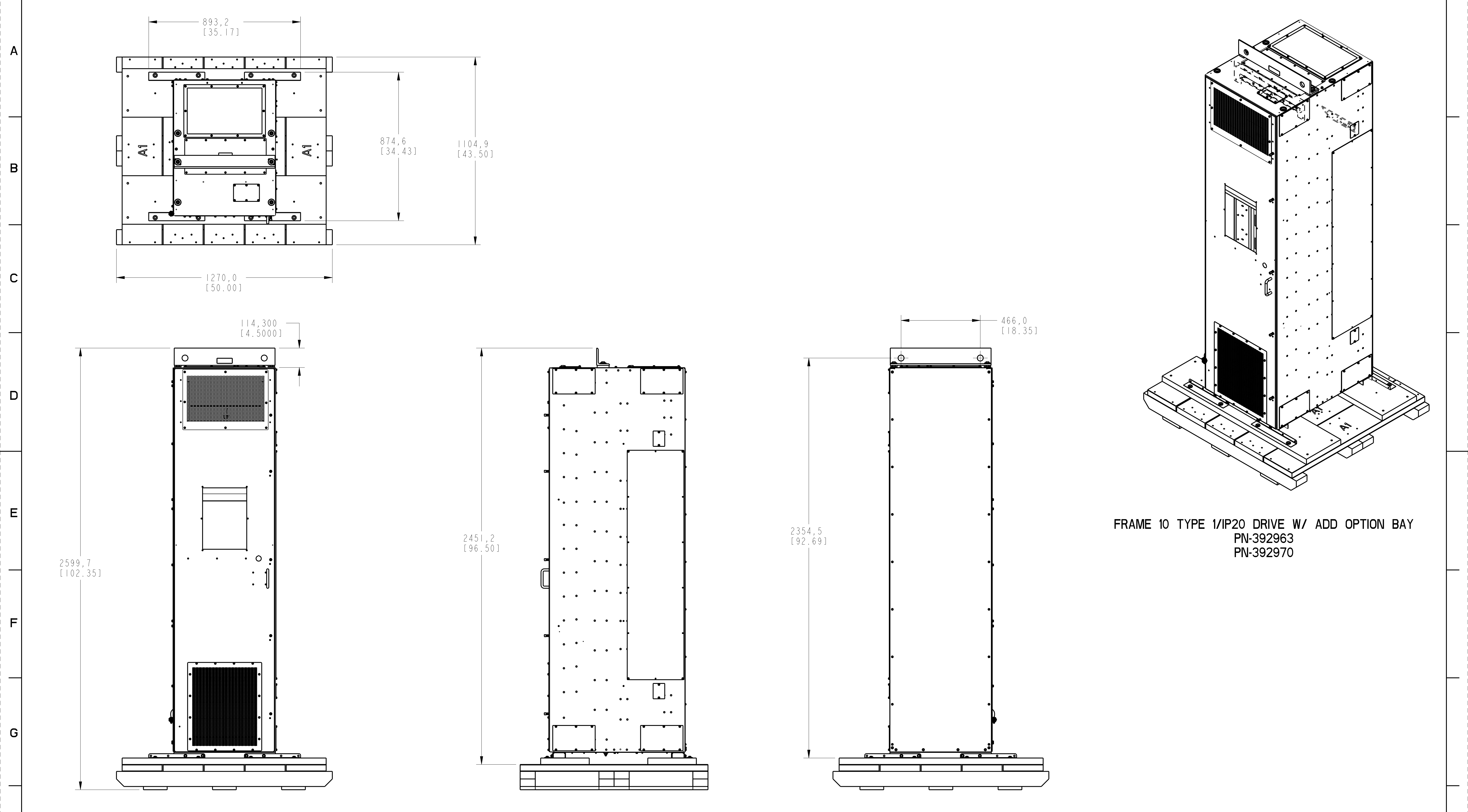

FRAME 10 TYPE 1/IP20 DRIVE W/ ADD OPTION BAY
 PN-392963
 PN-392970

DIMENSIONS APPLY BEFORE SURFACE TREATMENT
 DIMENSIONS IN MILLIMETERS
 TOLERANCES UNLESS OTHERWISE SPECIFIED

| | |
|-------|------|
| .X:± | 0,8 |
| .XX:± | 0,51 |
| ANG:± | 1° |

Rockwell Automation

STANDARD PF750-FRAME-10-AC-800mm
 OPTION BAY-IP20

Drawn by: RSUBRAMI Date: APR-28-2017

CONFIDENTIAL AND PROPRIETARY INFORMATION
 THIS DOCUMENT CONTAINS CONFIDENTIAL AND PROPRIETARY INFORMATION OF ROCKWELL AUTOMATION, INC. AND MAY NOT BE USED, COPIED OR DISCLOSED TO OTHERS, EXCEPT WITH THE AUTHORIZED WRITTEN PERMISSION OF ROCKWELL AUTOMATION, INC.

| | |
|----------------|-----|
| Sheet 19 Of 36 | Ver |
| D 10000222178 | 10 |

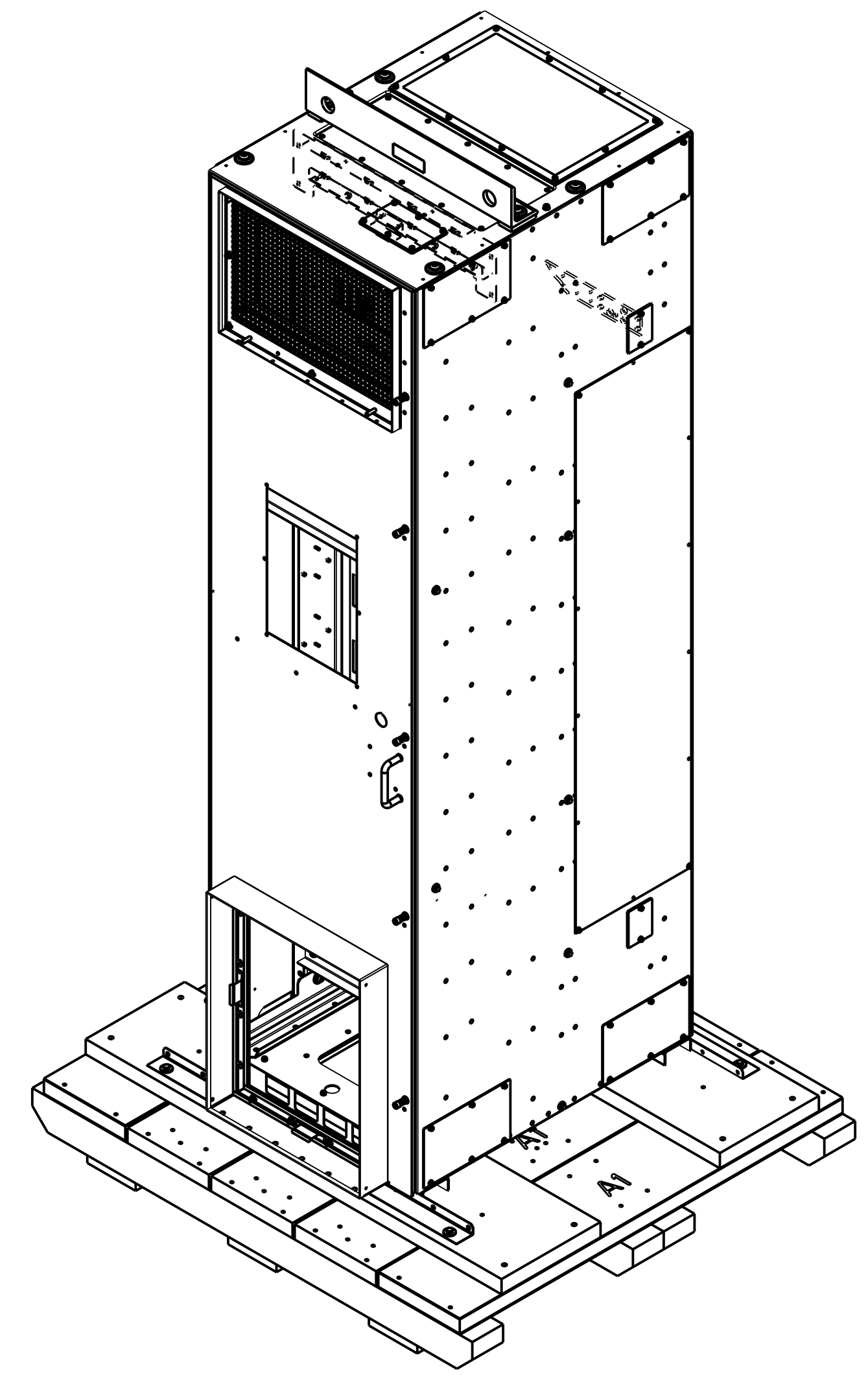
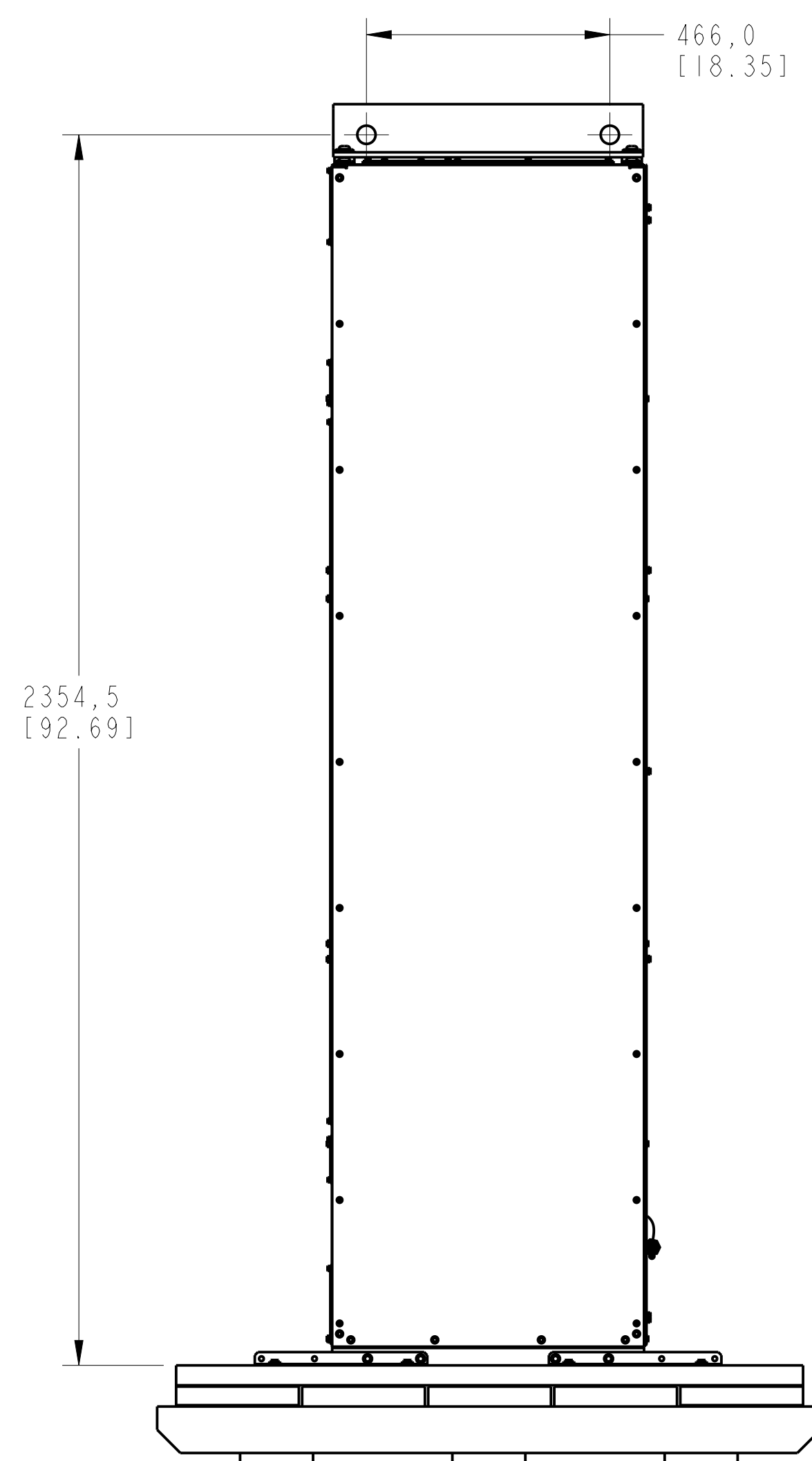
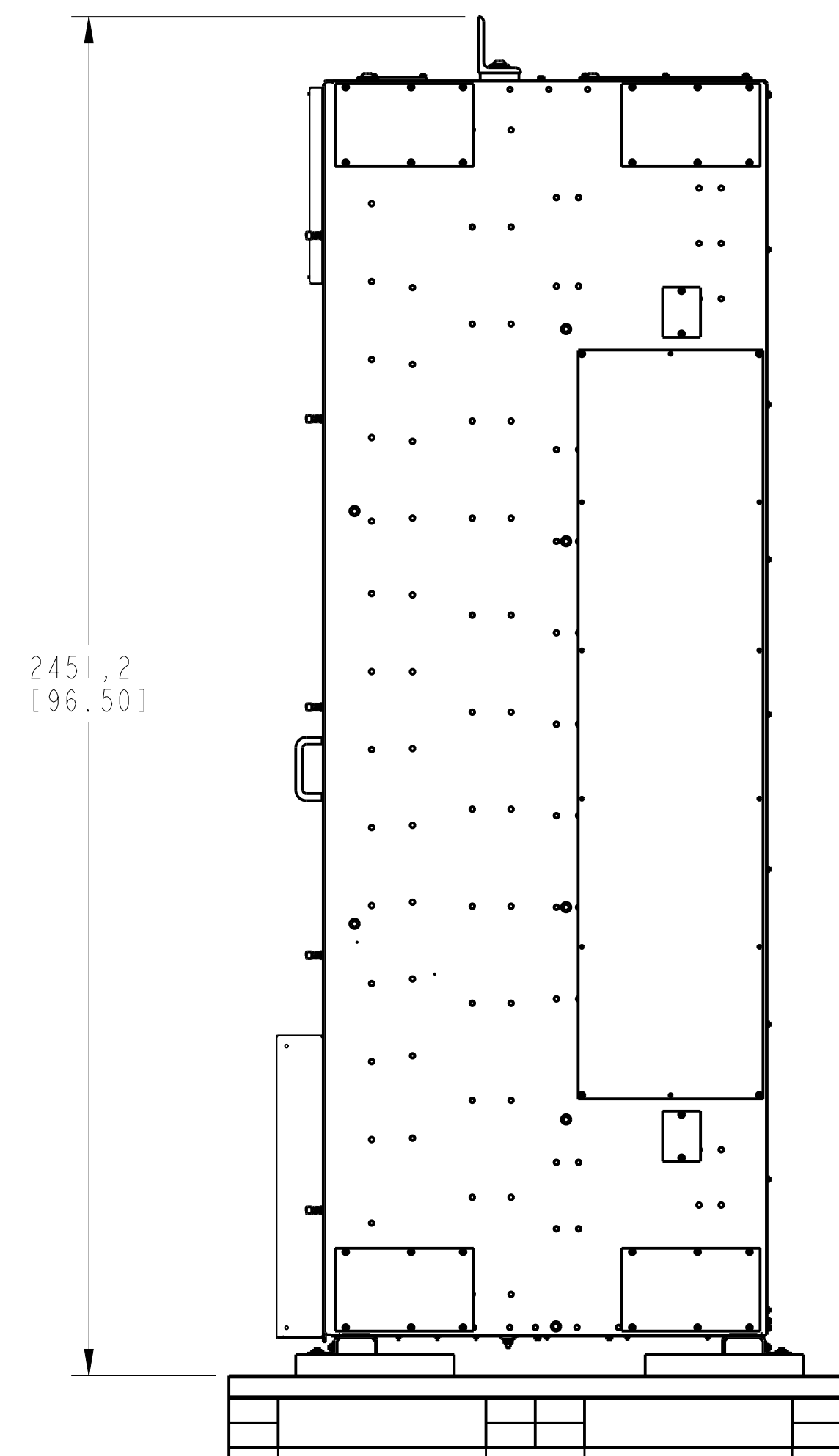
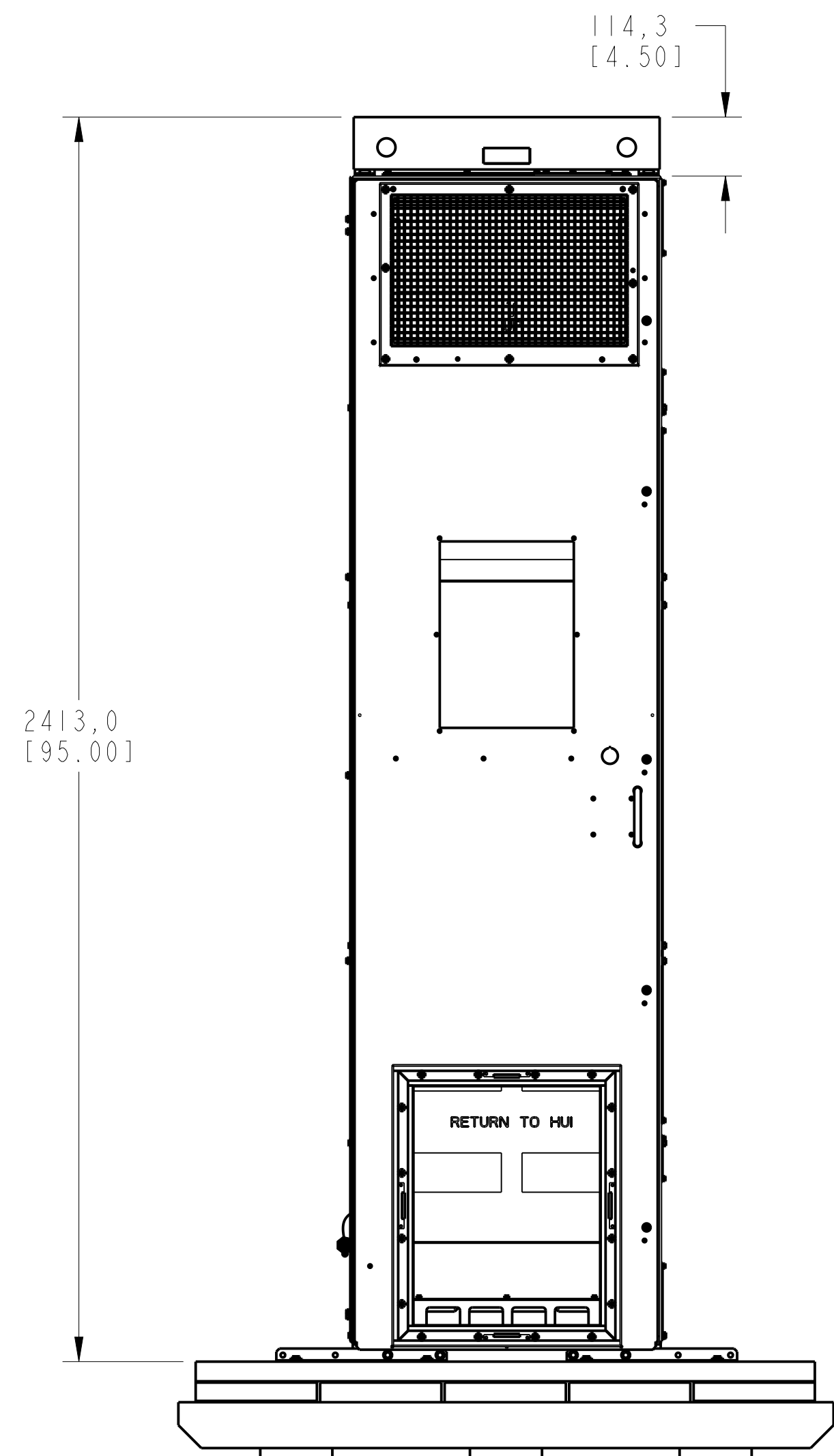
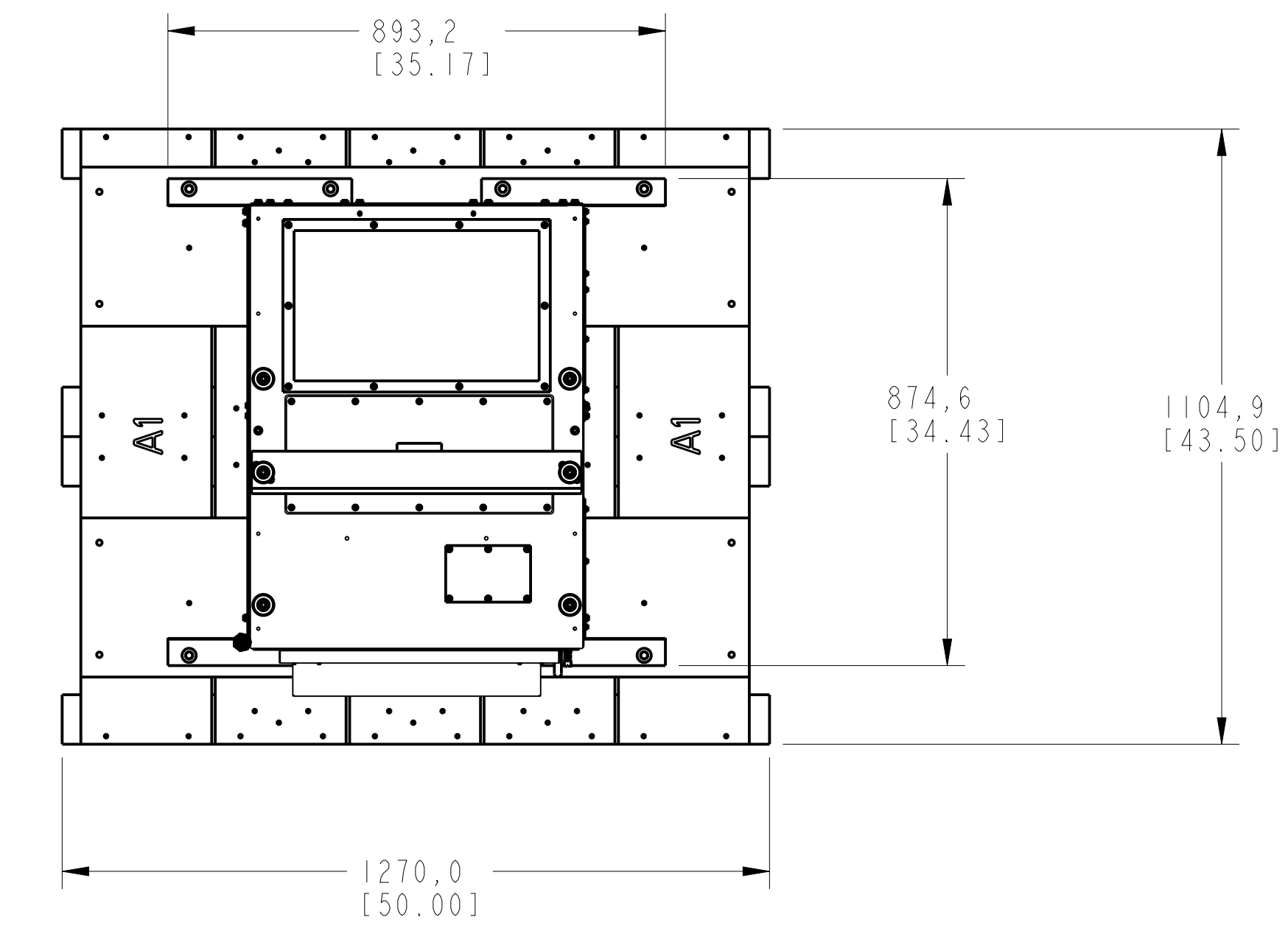

FRAME 10 TYPE 12/IP54 DRIVE W/ ADD OPTION BAY
 PN-393227
 PN-393231

| | | | |
|--------------------|--|--|----------------|
| | | <small>CONFIDENTIAL AND PROPRIETARY INFORMATION. THIS DOCUMENT CONTAINS CONFIDENTIAL AND PROPRIETARY INFORMATION OF ROCKWELL AUTOMATION, INC. AND MAY NOT BE USED, COPIED OR DISCLOSED TO OTHERS, EXCEPT WITH THE AUTHORIZED WRITTEN PERMISSION OF ROCKWELL AUTOMATION, INC.</small> | |
| | | STANDARD PF750-FRAME-10-AC-800mm OPTION BAY-IP54 | Sheet 20 Of 36 |
| Drawn by: RSUBRAMI | | Date: OCT-30-2020 | |

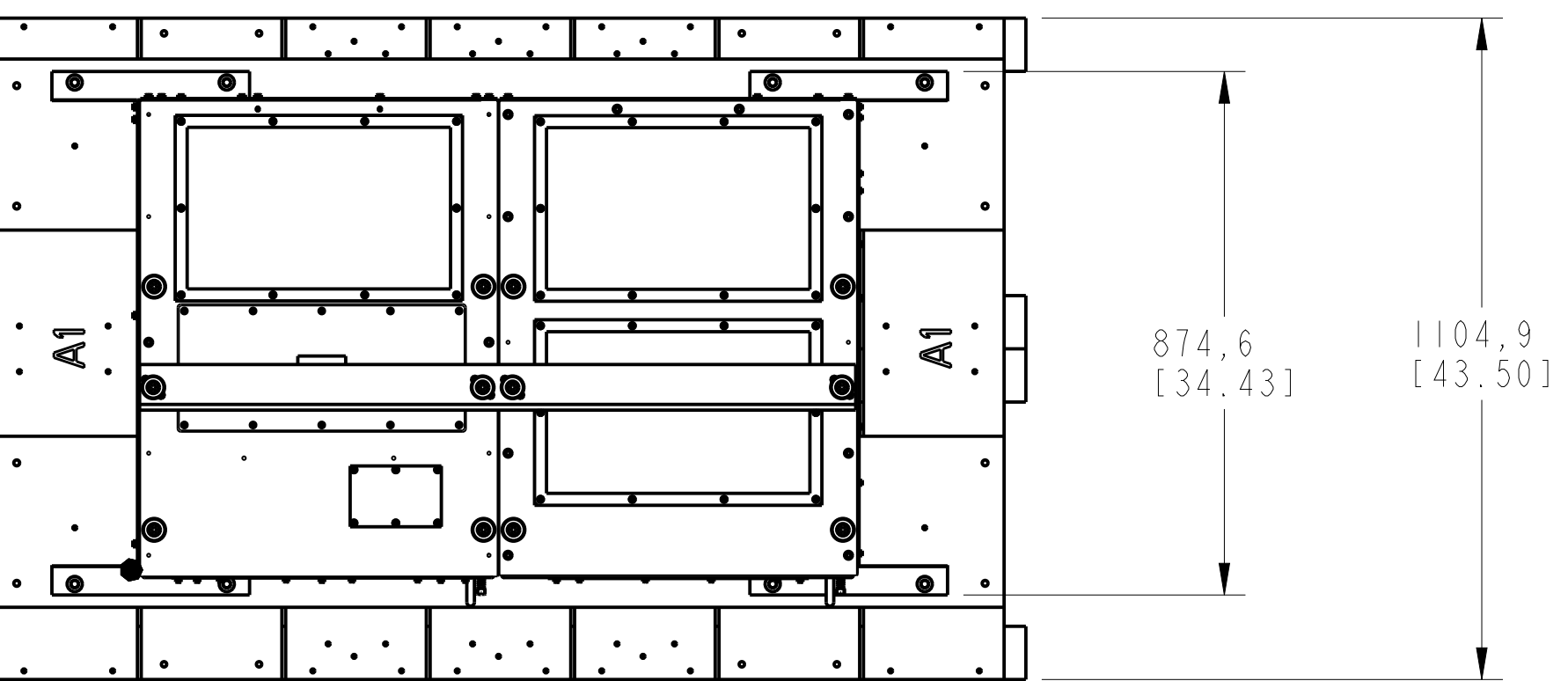

FRAME 10 TYPE 1 / IP20 DRIVE W/ ADD OPTION BAY & WIRE BAY
 PN-392966
 PN-392971

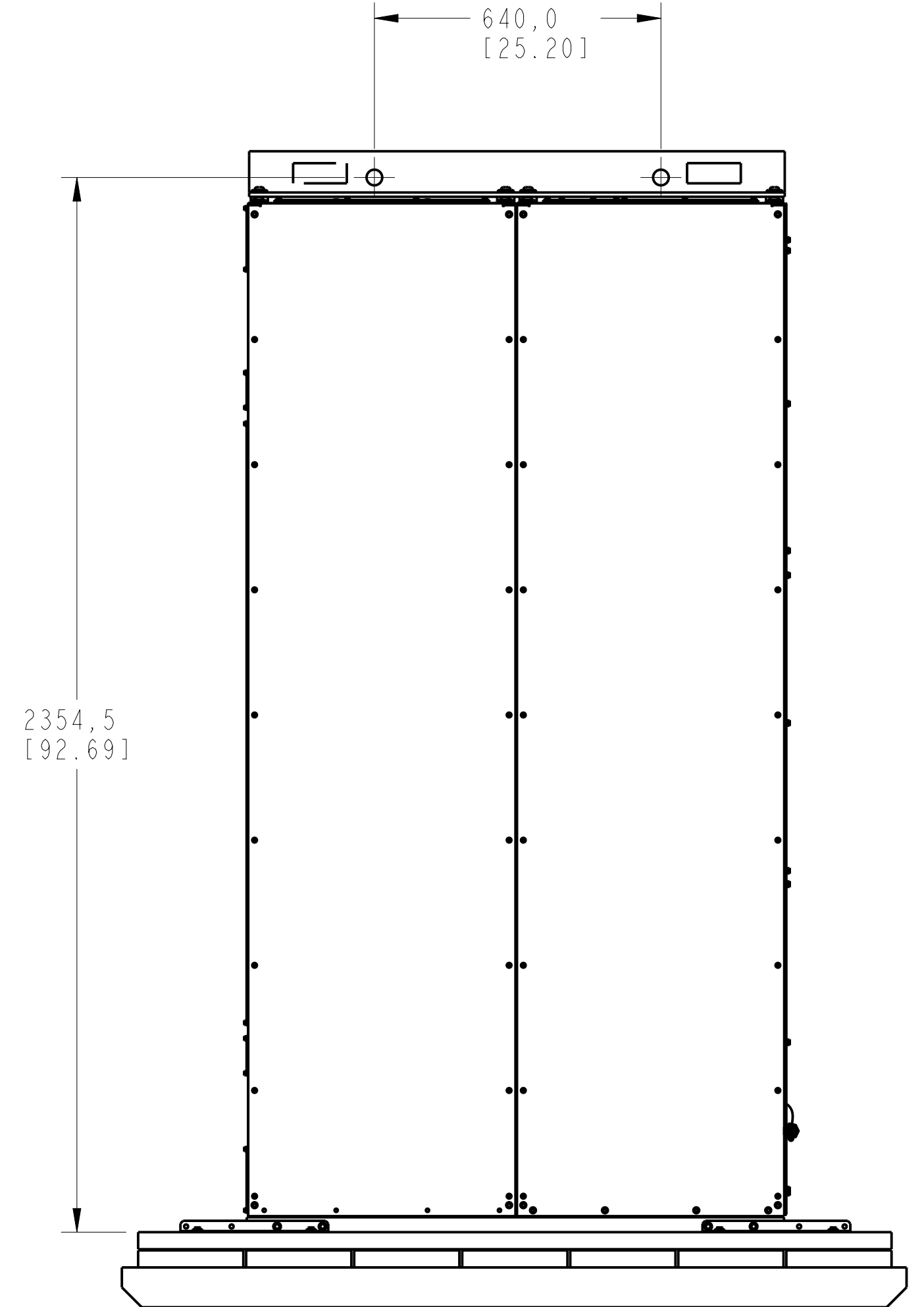
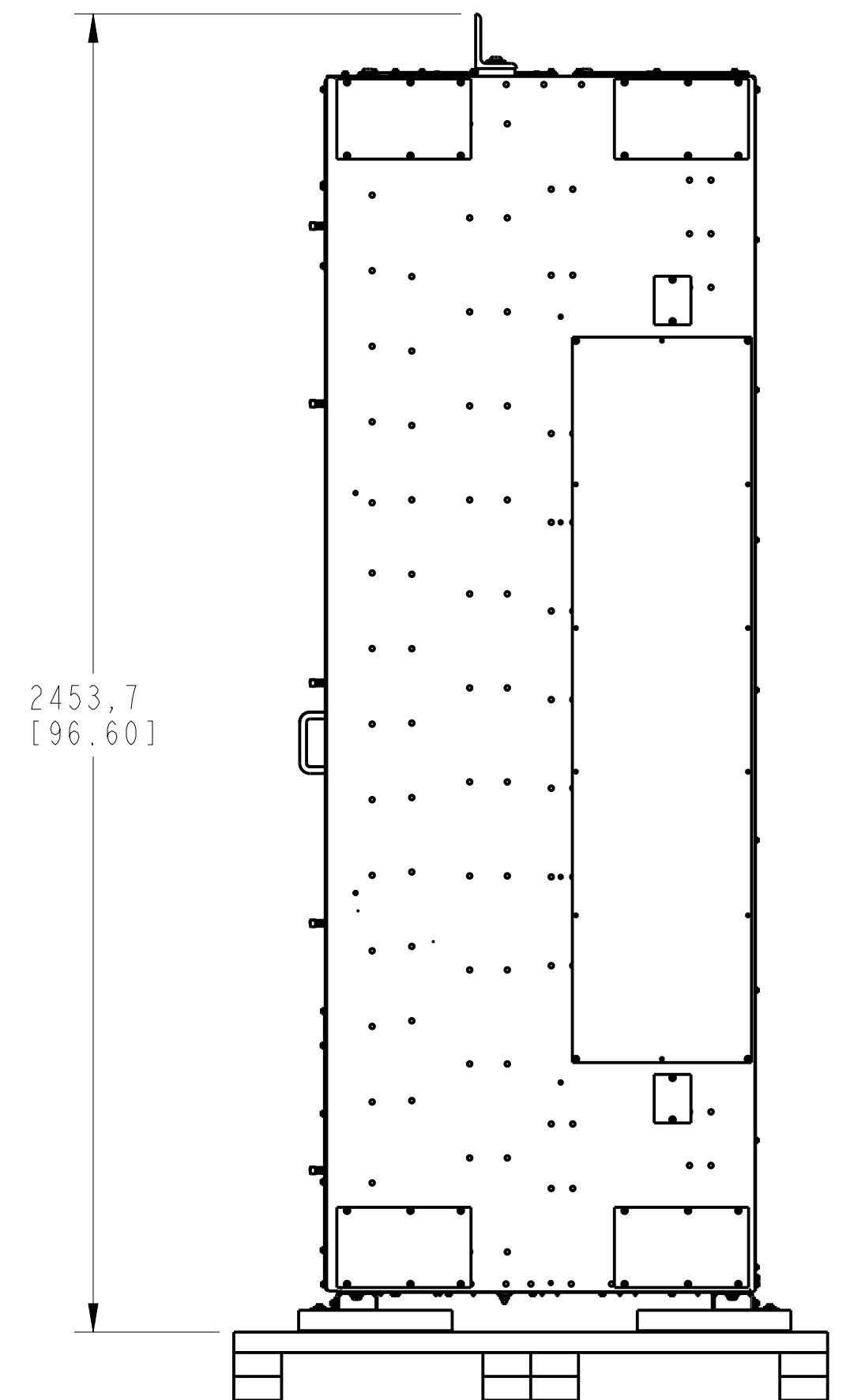
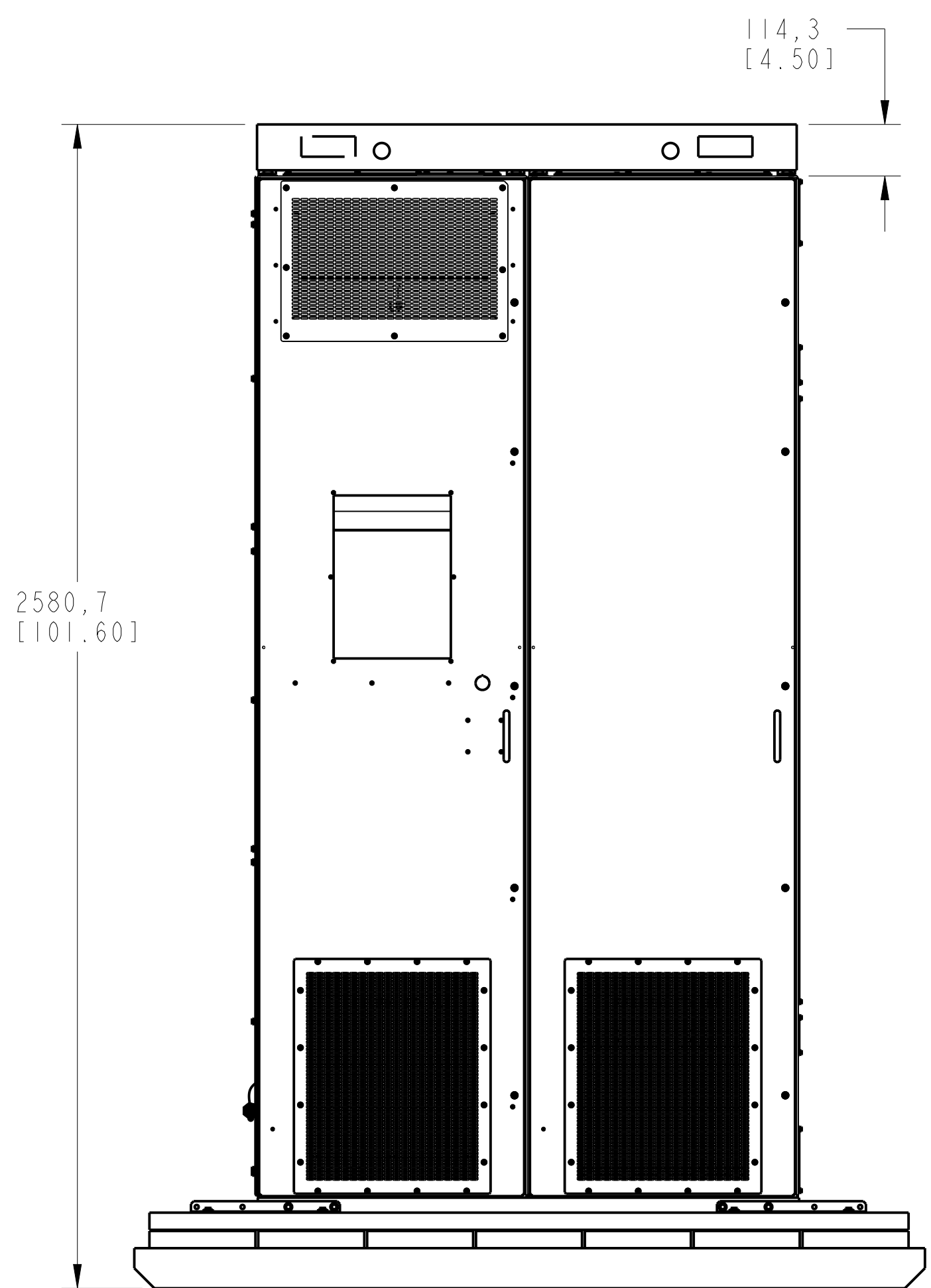
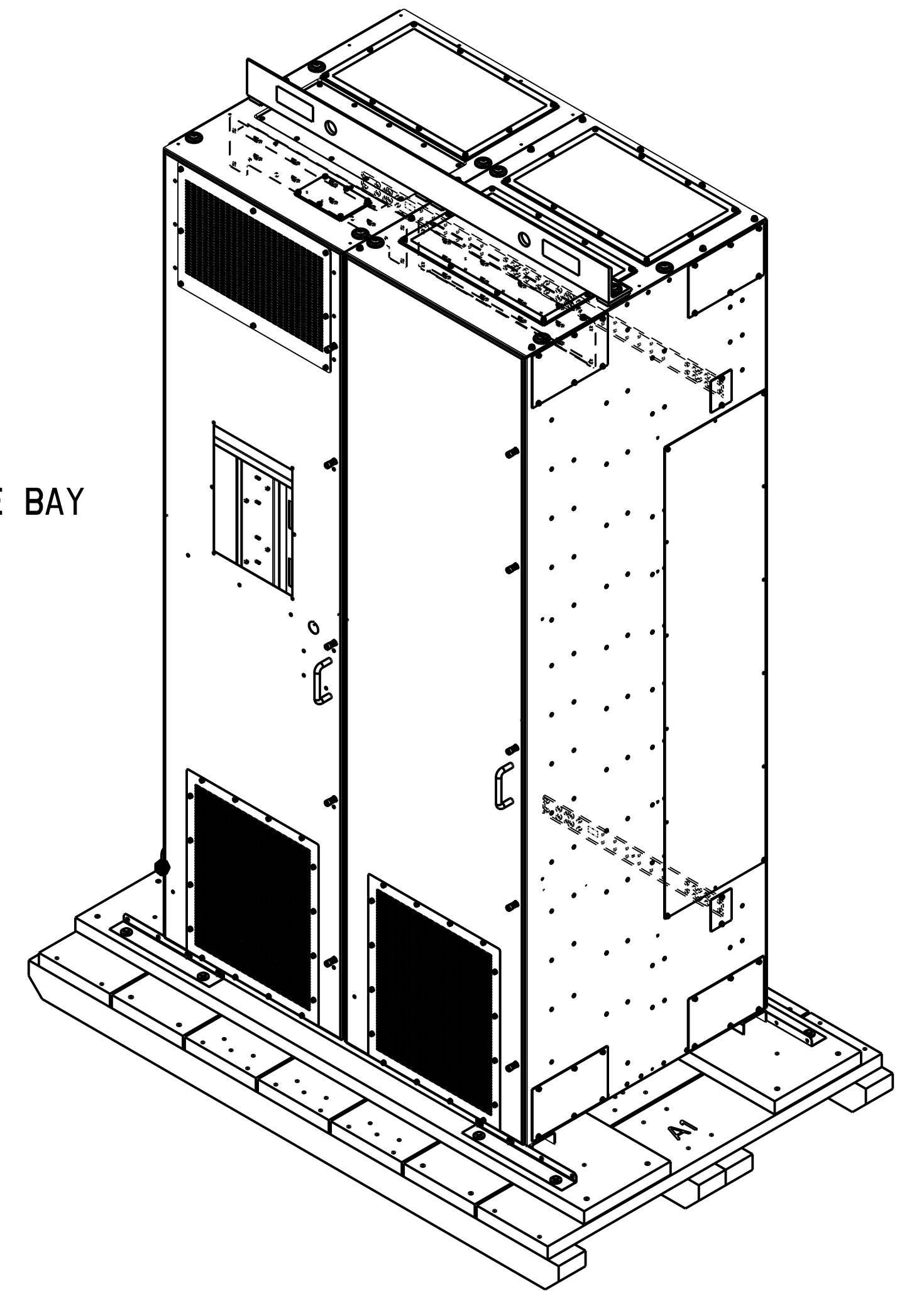

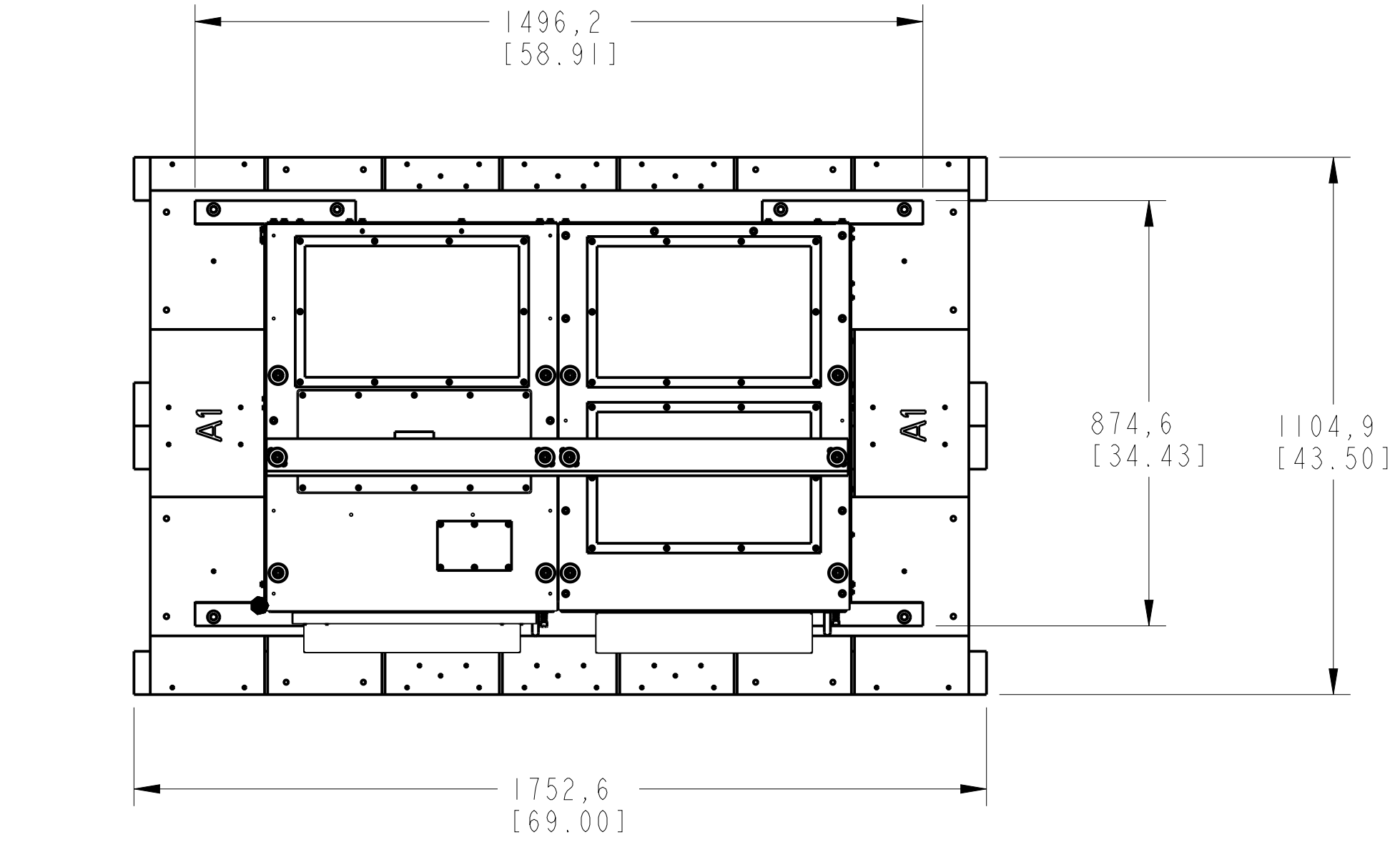

FRAME 10 TYPE 12 / IP54 DRIVE W/ ADD OPTION BAY & WIRE BAY
 PN-393229
 PN-393232

